

μC²SE for process chiller

CAREL

Electronic controller



ENG

User manual

→ **LEGGI E CONSERVA
QUESTE ISTRUZIONI** ←
**READ AND SAVE
THESE INSTRUCTIONS**

  **NO POWER
& SIGNAL
CABLES
TOGETHER**
READ CAREFULLY IN THE TEXT!

ATTENTION



CAREL bases the development of its products on several years' experience in the HVAC field, on continuous investment in technological innovation of the product, on rigorous quality procedures and processes with in-circuit and function tests on 100% of its production, on the most innovative production technologies available on the market. CAREL and its branch offices/affiliates do not guarantee, in any case, that all the aspects of the product and the software included in the product will respond to the demands of the final application, even if the product is built according to state-of-the-art techniques. The client (builder, developer or installer of the final equipment) assumes every responsibility and risk relating to the configuration of the product in order to reach the expected results in relation to the specific final installation and/or equipment. CAREL in this case, through specific agreements, can intervene as consultant for the positive result of the final start-up machine/application, but in no case can it be held responsible for the positive working of the final equipment/apparatus. The CAREL product is a state-of-the-art product, whose operation is specified in the technical documentation supplied with the product or can be downloaded, even prior to purchase, from the website www.carel.com. Each CAREL product, in relation to its advanced technological level, needs a phase of definition / configuration / programming / commissioning so that it can function at its best for the specific application. The lack of such phase of study, as indicated in the manual, can cause the final product to malfunction of which CAREL cannot be held responsible.

Only qualified personnel can install or carry out technical assistance interventions on the product.

The final client must use the product only in the manner described in the documentation related to the product itself.

Without excluding proper compliance with further warnings present in the manual, it is stressed that in any case it is necessary, for each CAREL product:

- Not allow the electronic circuits getting wet. Rain, humidity and all types of liquids or condensate contain corrosive mineral substances that can damage the electrical circuits. In any case, the product should be used and stored in environments that respect the temperature and humidity limits specified in the manual;
- Not to install the device in a particularly hot environments. Temperatures that are too high can shorten the duration of the electronic devices, damaging them and distorting or melting the parts in plastic. In any case, the product should be used and stored in environments that respect the temperature and humidity limits specified in the manual;
- Not to try to open the device in any way different than that indicated in the manual;
- Not to drop, hit or shake the device, because the internal circuits and mechanisms could suffer irreparable damage.
- Not to use corrosive chemical products, aggressive solvents or detergents to clean the device;
- Not to use the product in application environments different than those specified in the technical manual.

All the above reported suggestions are also valid for the control, serial boards, programming keys or however for any other accessory in the CAREL product portfolio.

CAREL adopts a continuous development policy. Therefore, CAREL reserves the right to carry out modifications and improvements on any product described in this document without prior notice.

The technical data in the manual can undergo modifications without forewarning.

The liability of CAREL in relation to its own product is governed by CAREL's general contract conditions edited on the www.carel.com and/or by specific agreements with clients; in particular, within the criteria consented by the applicable norm, in no way will CAREL, its employees or its branch offices/affiliates be responsible for possible lack of earnings or sales, loss of data and information, cost of replacement goods or services, damage to objects or persons, work interruptions, or possible direct, indirect, accidental, patrimonial, coverage, punitive, special or consequential damage in any way caused, be they contractual, out-of-contract, or due to negligence or other responsibility originating from the installation, use or inability of use of the product, even if CAREL or its branch offices/affiliates have been warned of the possibility of damage.

DISPOSAL

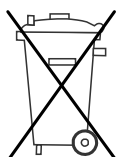

INFORMATION FOR THE USERS REGARDING THE CORRECT HANDLING OF WASTE ELECTRIC AND ELECTRONIC EQUIPMENT (WEEE)

With reference to European Parliament and Council Directive 2002/96/EC issued on 27 January 2003 and the related national implementation legislation, please note that:

- WEEE cannot be disposed of as municipal waste, said waste must be collected separately;
- the public or private waste collection systems defined by local legislation must be used. Moreover, the equipment can be returned to the distributor at the end of its working life when buying new equipment;
- this equipment can contain hazardous substances: improper use or incorrect disposal of such may have negative effects on human health and on the environment;
- the symbol (crossed-out wheeled bin) shown on the product or on the packaging and on the instruction sheet indicates that the equipment has been introduced onto the market after 13 August 2005 and that it must be disposed of separately;
- in the event of illegal disposal of electrical and electronic waste, the penalties are specified by local waste disposal legislation.

Materials warranty: 2 years (from the date of production, excluding consumables).

Type-approval: the quality and safety of CAREL S.P.A. products are guaranteed by the design system and ISO 9001 certified production.

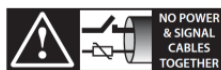

READ CAREFULLY IN THE TEXT!

ATTENTION: separate the probe cables and the digital input cables as much as possible from the inductive load and power cables to prevent possible electro-magnetic interference. Never introduce power cables and signal cables (including those of electric control board) into the same cable troughs..

Content

1. INTRODUCTION	7
1.1 General description	7
1.2 Codes	7
1.3 Accessories	7
2. INSTALLAT	9
2.1 Type of fixing and dimensions	9
2.2 Operational layouts	9
2.3 $\mu\text{C}^2\text{SE}$ Wiring diagram	10
2.4 I/O board Wiring diagram	10
2.5 Optional connection	10
2.6 Inputs/outputs labelling	10
2.7 Connection with CONV0/10VA0 and CONVONOFF0 modules (accessories)	11
2.8 Installaton	11
2.9 Programming key (copy of the set-up)	12
3. USER INTERFACE	14
3.1 Display	14
3.2 Keypad	14
3.3 Example: timer reset	14
3.4 Programming	14
3.5 Menu structure	15
4. COMMISSIONING	16
4.1 Firmware version	16
4.2 Configuration	16
4.3 Minimum and maximum fan speed calculation	17
5. FUNCTIONS	18
5.1 Set point	18
5.2 Probes (analogue inputs)	18
5.3 Probe reading	19
5.4 Digital inputs	19
5.5 Digital outputs	20
5.6 Analogue outputs	21
5.7 Compensation	21
5.8 Low load	21
6. CONTROL	22
6.1 Anti-freeze	22
6.2 Anti-freeze automatic switch-on	22
6.3 Anti-freeze with EVD ⁴	22
6.4 Compressors management	22
6.5 Pumps management	25
6.6 Compressor – evaporator pump/valve delays	25
6.7 Fan management	26
6.8 Hot gas bypass	27
6.9 Pump down	27
6.10 Heaters management	27
7. PARAMETER TABLE	28
7.1 $\mu\text{chiller}^2\text{SE}$ process parameters table	28
7.2 Variables accessible only by supervision	31
8. ALARMS	32
8.1 Type of alarms	32
8.2 Alarm description	33
8.3 Alarm digital inputs/outputs	35
9. TECHNICAL SPECIFICATIONS	36
9.1 Software releases	37

1. INTRODUCTION

1.1 General description

μC²SE for process chiller is a compact electronic controller designed for the complete management of the process chiller with 1 refrigerating circuit: it can control air-water and water-water machines. The controller has 5 digital inputs, 5 digital outputs, 4 analogue inputs and 1 analogue output. It can be installed:

- individually;
- connected to the tLAN network with the EVD⁴ driver to manage the electronic expansion valve;
- connected in tLAN network with inputs/outputs expansion board.

The PWM output can be converted using the following modules:

- CONV0/10A0: conversion from PWM output for SSR into a linear analogue signal 0...10 Vdc and 4...20 mA;
- CONONOFF0: conversion from PWM output for SSR into an On/Off output from relay.

Main functions

Briefly:

- control of: compressor, condenser fan, water pump for evaporator and/or condenser, anti-freeze heaters, alarm signal devices;
- regulation of the set-point on evaporator input probe (B1), evaporator output probe (B2) or differential (B1-B2);
- condenser fan/pump speed control;
- complete alarms management;
- elimination of storage vessel in event of low load;
- serial connection to the EVD⁴ driver for control of the electronic expansion valve;
- serial connection to the I/O expansion board for:
 1. connection of devices (thermostats/pressure switches) to digital inputs of the I/O board;
 2. display of further warnings/alarms on the controller display;
 3. selection of the digital outputs to switch-over.

1.2 Codes

Description	Cod.
μC ² SE 1 circuit, 2 compressors, panel assembly	MCH2000050
μC ² SE 1 circuit, 2 compressors, panel assembly (20 pieces)	MCH2000051
μC ² SE I/O board	MCH2000060
RS485 optional board for μC ² SE	MCH2004850
Programming key for μC ² SE with 230 V power supply unit	PSOPZKEYA0
PWM-On/Off converter board	CONVONOFF0
PWM-0...10 V converter board	CONV0/10A0
Temperature probes: *** depending on the length (015= 1.5 m, 030= 3 m, 060=6 m)	NTC***WP00
Pressure probes for condenser control ** depending on the pressure (13= 150 PSI, 33= 500 PSI)	SPKT00**R0
Connectors kit for code MCH2000051 (multi-pack 20 pieces)	MCH2CON001
Minifit connectors kit +cables measuring 1 m for code. MCH2**	MCHSMLCAB0
Minifit connectors kit +cables measuring 2 m for code. MCH2**	MCHSMLCAB2
Minifit connectors kit + cables measuring 3 m for code. MCH2**	MCHSMLCAB3
Remote terminal for MCH2000050 for panel assembly	MCH200TP00
Remote terminal for MCH2000050 for wall assembly	MCH200TW00
Serial connection kit for remote terminal supervisor	MCH200TSV0

Boards with PWM output for fan speed control:

4A/230 Vac	MCHRTF04C0
8A/230 Vac	MCHRTF08C0
12A/230 Vac	MCHRTF12C0
10A/230 Vac 1 Pz.	MCHRTF10C0
10A/230 Vac 10 Pz.	MCHRTF10C1

1.3 Accessories

I/O board (cod. MCH2000060)



The board, connected in tLAN network to the controller, has 5 digital inputs and 5 digital outputs. The switch-over of every digital input can be associated to a determined alarm signal, shown on the controller display and also to a switch-over on the selected digital output.

Driver for electronic expansion valve (code EVD0000400 - tLAN)



The driver, connected in tLAN network to the controller, allows to control the electronic expansion valve in the cooling circuits. The condensation pressure probe must be connected to the controller, which will send it to the driver. See the manual code +030220227.

Fan speed management board (code MCHRTF*)



The driver, connected in tLAN network to the controller, allows to control the electronic expansion valve in the cooling circuits. The condensation pressure probe must be connected to the controller, which will send it to the driver. See the manual code +030220227.

Fan speed management board (code FCS3*)



The FCS range appliances are electronic three-phase voltage regulators that use the phase cut principle to regulate the output voltage supplied to the load, depending on the command signal applied to the input. They can drive asynchronous electric motors connected, for example, to axial fans, pumps, mixers, stirrers etc.

CONVONOFF0 module



Converts a PWM signal for relay in solid state into ON/OFF output obtained with a relay. The relay boards with CONVONOFF0 code, allow the ON/OFF management of the condenser fans. The command relay has a changeable power of 10 A at 250 Vac into AC1 (1/3 HP inductive).

Analogue output module (code CONV0/10A0)



Converts a PWM signal for relay in solid state into an output 0...10 Vdc or 4...20 mA. The three-phase regulators of the FCS range can be connected to the controller without the use of this module.

RS485 Converter (code MCH2004850)



Allows the controller to be connected to a supervision network with RS485 standard serial line. To do this, it is used the input normally engaged for the programming key with the double function of key input/serial communication port.

Remote terminal (code MCH200T*00)



Allows the complete configuration of the remote controller. The use of the keys and the indications on the display faithfully reproduce the $\mu\text{C}^2\text{SE}$ user interface. It is also possible to connect the PlantVisor to the remote control terminal via relative accessory. The version exists for panel assembly (MCH200TP00) and for wall assembly (MCH200TW00). For further information see the instruction sheet +050001065.

Programming key (code PSOPZKEY*0)



The programming keys PSOPZKEY00 and PSOPZKEYA0 for CAREL controllers allow the copying of the complete set of parameters of the $\mu\text{C}^2\text{SE}$. The keys must be connected to the connector (AMP 4 pin) envisioned in the controllers and can operate with controllers powered or not. The main upload/download functions envisioned are selected via two micro switches. These are:

- loading the parameters of a controller into the key (UPLOAD);
- copying the key onto one or more controllers (DOWNLOAD).

2. INSTALLAT

2.1 Type of fixing and dimensions

$\mu\text{C}^2\text{SE}$ for process chiller is supplied with connectors of different format to facilitate the electric connections. The EVD⁴ driver and the I/O board must be installed on DIN guide.

Dimensions (mm)

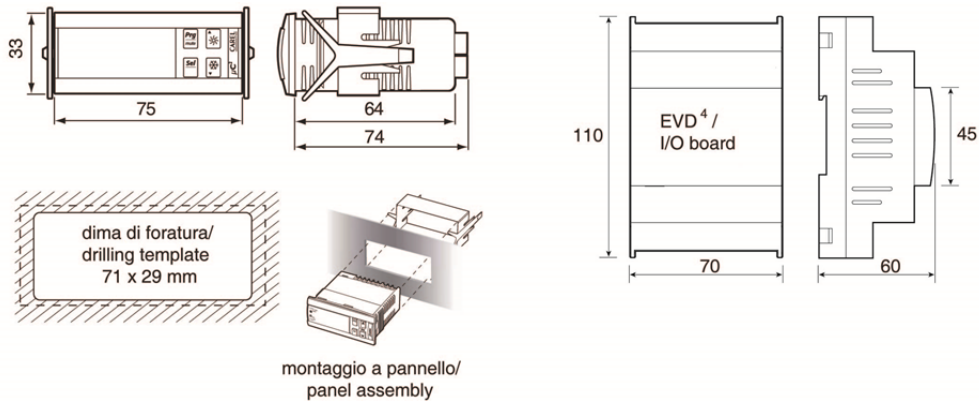

2.2 Operational layouts

Below find the structure of the tLAN network, with the $\mu\text{C}^2\text{SE}$ controller for process chiller, which can operate alone or with the I/O expansion board. The EVD⁴ driver is an optional.

NETWORK STRUCTURE

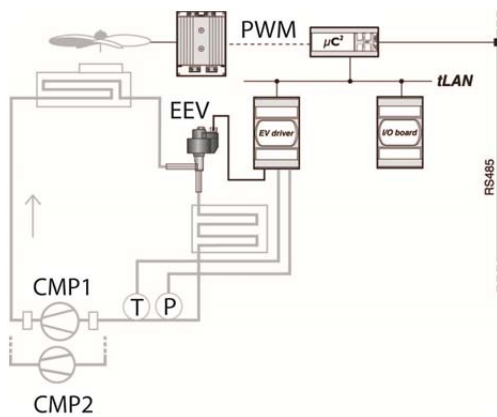

Key

T	Evaporation temperature
P	Evaporation pressure
B1	Evaporator input probe
B2	Evaporator output probe
B3/B4	Condenser probe
C	Condenser
E	Evaporator
R	Heater
FL	Flow switch
CMP1/2	Compressor 1/2
EV	Expansion valve
EEV	Electronic expansion valve
F	Condenser fan
EP	Evaporator pump
CP	Condenser pump

AIR - WATER CHILLER

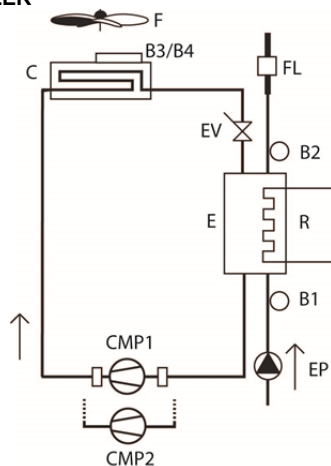

WATER - WATER CHILLER

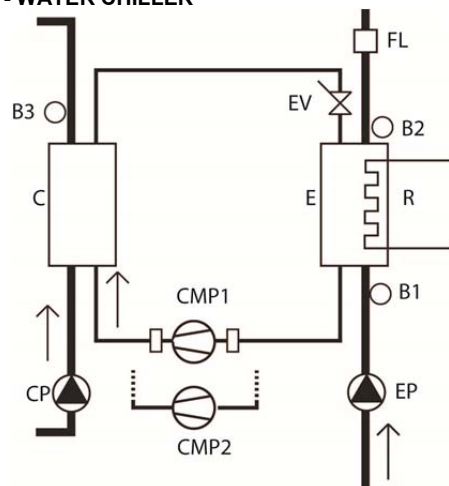

2.3 $\mu\text{C}^2\text{SE}$ Wiring diagram

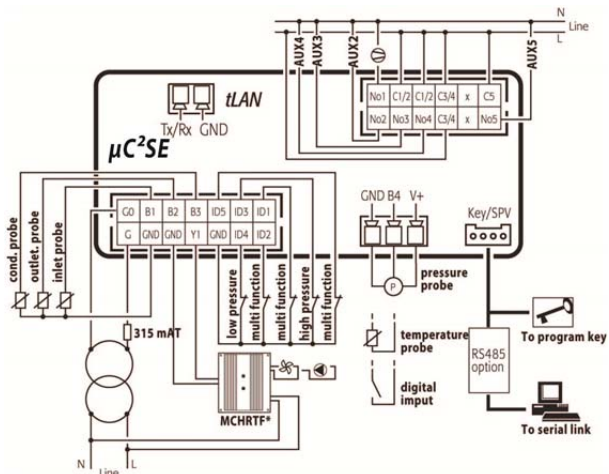

Key

G	24 Vac power supply
G0	Power supply reference
B1...B4	Analogue inputs 1...4
ID1...ID5	Digital inputs 1...5
C1...C5	Common digital outputs 1...5
NO1...NO5	Digital outputs 1...5 normally open contact
Y1	Analogue output 1
Key/SPV	Connector for key/supervisor
V+	Ratiometric pressure probe power supply
Tx/Rx	tLAN port
Ground	



Note:

l'uscita digitale 1 non è programmabile ed è destinata al compressore; gli ingressi analogici B1 e B2 sono riservati rispettivamente alle sonde ingresso e uscita evaporatore.

2.4 I/O board Wiring diagram

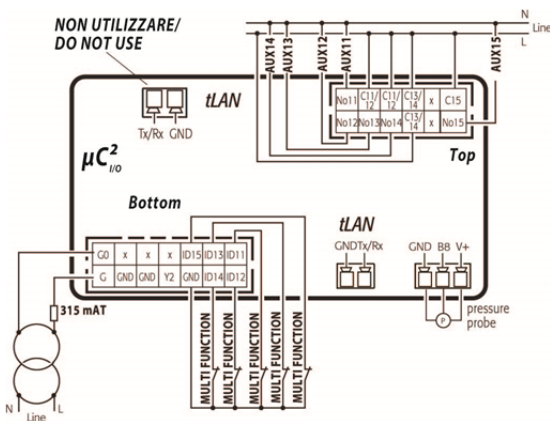

Key

G	24 Vac power supply
G0	Power supply reference
ID11...ID15	Digital inputs 11...15
B8	Analogue input 8
C11...C15	Common digital outputs 11...15
NO11...NO15	Digital outputs 11...15 normally open contact
V+	Ratiometric pressure probe power supply
Y2	Analogue output 2
Tx/Rx	tLAN port
Ground	

2.5 Optional connection

The programming key input can be used successively for the connection to the supervision network via RS485 converter.

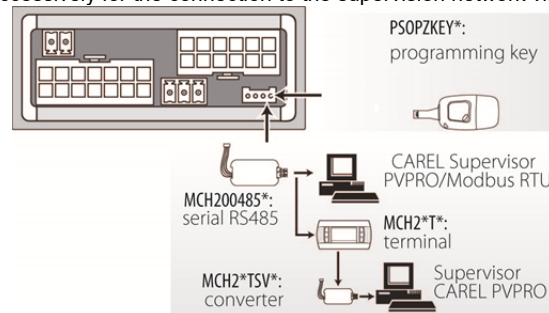

2.6 Inputs/outputs labelling

	$\mu\text{C}^2\text{SE}$	I/O expansion board
Analogue inputs	B1...B4	B8
Digital inputs	ID1...ID5	ID11...ID15
Analogue outputs	Y1	Y2
Digital outputs	NO1...NO5	NO11...NO15



Notes:

only probe B8 can be connected to the I/O expansion board; the numbering of the digital inputs/outputs of the expansion board goes from 11 to 15.



If the serial line is connected in supervision mode, do not connect to earth the secondary terminal of the supply transformer of the control.

2.7 Connection with CONV0/10VA0 and CONVONOFF0 modules (accessories)

The CONV0/10VA0 and CONVONOFF0 modules allow to convert a PWM output for SSR respectively into an analogue output 0...10Vdc and into an ON/OFF output with relay. Note that with the same controller 3 different types of outputs can be obtained.

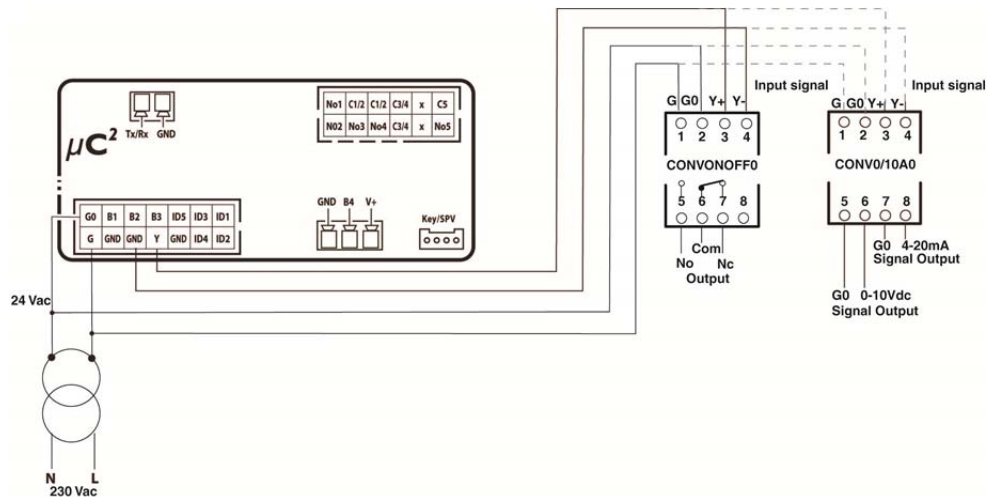

Key

CONV0/10A0 - CONVONOFF0 module		CONV0/10A0 module		CONVONOFF0 module	
Terminal	Description	Terminal	Description	Terminal	Description
1	24 Vac power supply	5	0...10 Vdc output reference	5	Normally open
2	Power supply reference	6	0...10 Vdc output	6	Common
3	PWM (+) command signal	7	4...20 mA output reference	7	Normally closed
4	PWM (-) command signal	8	4...20 mA output	8	Not connected

The command signal to terminals 3 and 4 of the CONV0/10VA0 and CONVONOFF modules is optically-isolated. This allows the power supply G, G0 can be in common with the controller power supply.

2.8 Installaton

General warnings



Disconnect power supply before working on the board during assembly, maintenance and replacement.

Do not install the controllers in environments with the following features:

- relative humidity over 90% or condensing;
- strong vibrations or blows;
- exposure to continuous jets of water;
- exposure to aggressive and polluting atmospheres (e.g. sulphuric and ammonia gases, saline mists, fumes) to prevent corrosion and/or oxidation;
- high magnetic and/or radiofrequency interference (avoid installation of the equipment near to transmitting antennas);
- exposure of the controllers to direct solar radiation and atmospheric agents in general.

The following recommendations must be respected when connecting the controllers:

- the incorrect connection to the power supply voltage can seriously damage the controller;
- separate the probe cables and the digital input cables as much as possible (at least 3 cm) from the inductive load and power cables to prevent possible electro-magnetic interference. Never introduce power cables and probe cables (including those of electric control board) into the same cable conduits.
- do not install the probe cables in the immediate vicinity of power devices (switches, magnet circuit breaker switches, etc.). Reduce the probe cable pathway as much as possible and do not allow routes that enclose power devices;
- do not power the controller directly from the main panel power supply if also supplying power to other devices, such as switches, solenoid valves etc. which will require another transformer. The controller is not an appliance that guarantees electrical safety, but simply suitable operation: to prevent a dangerous situation being generated following a short circuit or overload, the customer must install suitable electro-mechanical cut-off devices on the lines of interest (fuses or similar).

Electric connections

Proceed as follows for installation, making reference to the wiring diagrams:

1. Connect probes and power supply: the probes can be installed up to a maximum distance of 10 metres from the controller as long as shielded cables with minimum section of 1 mm² are used. To improve immunity to interference, it is recommended to use probes with shielded cable (connect just one end of the shield to the electric control board earth).
2. Program the controller: see the "User interface" chapter.
3. Connect the actuators: it is preferable to connect the actuators only after having programmed the controller. It is recommended to carefully evaluate the maximum capacities of the relays indicated in the "technical specifications".
4. Connect the serial network: if the connection to the supervision network is envisioned via the relevant serial boards (code MCH2004850), the system must be earthed. Make sure there is just one earth connection. In particular, the transformers secondary device, which powers the controllers, must not be connected to earth. If connection to a transformer with earthed secondary device is necessary, an isolation transformer must also be used. It is possible to connect several controllers to the same isolation transformer, however it is recommended to use one isolation transformer for every controller.

Case 1: several controllers connected in network powered by the same transformer (G0 not connected to earth). Typical application of several controllers inside the same electric control board

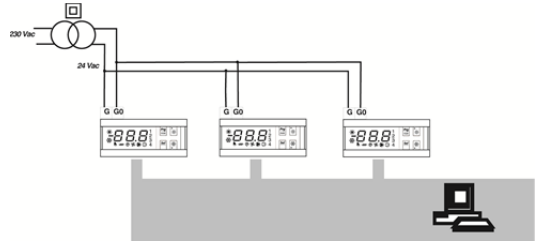

Case 2: several controllers connected in network powered by the different transformers (G0 not connected to earth). Typical application of several controllers that are part of different electric control boards.

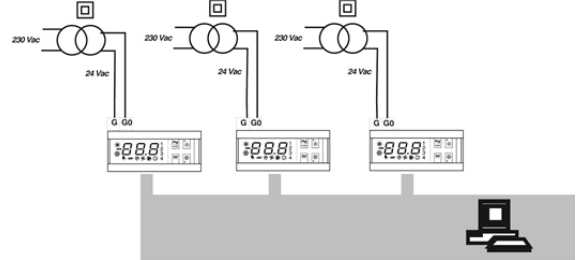

⚠ Attention:

- If one transformer is used to supply both the $\mu\text{C}^2\text{SE}$ and the accessories, all the G0 terminals on the various controllers or the various boards must be connected to the same terminal on the secondary, and all the G terminals to the other terminal on the secondary, so as to avoid damaging the controller;
- for use in residential environments, use shielded cable (two wires + shield earthed at both ends, AWG 20-22) for the tLAN connections (EN 55014-1);
- avoid short-circuits between V+ and GND so as not to damage the controller.
- perform all the maintenance and installation operations when the unit is not connected to the power supply;
- separate the power cables (relay outputs) from the cables corresponding to the probes, digital inputs and serial line;
- use a transformer dedicated exclusively to the electronic controllers for the power supply.

Protection against electric shock and maintenance warnings

The system made up of the control board (MCH200005*) and the other optional boards (MCH2000060, MCH2004850, MCHRTF****, CONVONOFF0, CONV0/10A0, EVD000040*) constitutes a control device to be integrated into class I or class II appliances. The class of protection against electric shock depends on how the control device is integrated into the unit built by the manufacturer. The protection against short circuits due to faulty wiring must be guaranteed by the manufacturer of the appliance that the controller will be fitted on.

2.9 Programming key (copy of the set-up)

The PSOPZKEY00 and PSOPZKEYA0 programming keys for CAREL controllers allow to copy the complete set of $\mu\text{C}^2\text{SE}$ parameters. The keys must be connected to the connector (AMP 4 pin) envisioned in the controllers and can operate with instruments that are live or not, according to that indicated in the user notes of the specific controller. There are two main functions envisioned and they are selected via two dip switches (situated under the battery lid). These are:
loading the parameters of a controller into the key (UPLOAD);
copying the key onto one or more controllers (DOWNLOAD).

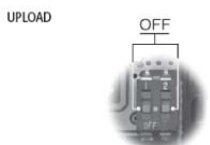

Fig.1



Fig.2

⚠ Parameters can only be copied via controllers with the same code. The data loading operation into the key (UPLOAD) is always allowed. To facilitate identification of the key to be used, CAREL has enclosed a label on which the programming loaded can be described or the machine to which it refers.



The key can only be used on $\mu\text{C}^2\text{SE}$ controllers that have the same Firmware version.

UPLOAD - copy parameters from controller to key

Procedure:

- open the rear door of the key and position the two dip-switches at OFF. Close the door;
- connect the key to the controller terminal;
- press the key button and hold, checking the signalling sequence of the LED: from red, it turns green after a few seconds;
- if the signalling sequence is that indicated above, the copying operation has been successful (green LED on); the button can be released and the key disconnected from the instrument. In the event of different signals: if the green LED does not switch on or if flashing, there is a problem. See the following table for the meanings of the signals.

DOWNLOAD - copy the parameters from the key to controller

Procedure:

- open the rear door of the key and position dip-switch n. 1 at OFF and dip-switch n. 2 at ON. Close the door;
- connect the key to the controller;
- press the key button and hold, checking the signalling sequence of the LED: from red, it turns green after a few seconds;
- if the signalling sequence is that indicated above, the copying operation has been successful (green LED on); the button can be released. After a few seconds the LED switches off and the key can be disconnected from the instrument;
- in the event of different signals: if the green LED does not switch on or if flashing, there is a problem. See the relative table for the meanings of the signals.

The operation is completed in 10 seconds. If the completed signal with green LED on is not given within this time period, it is good practice to attempt the operation again, releasing and pressing the button again. In the event of flashing, see the relative table for the meaning of the signal.

The operation is completed in 10 seconds. If the completed signal with green LED on is not given within this time period, it is good practice to attempt the operation again, releasing and pressing the button again. In the event of flashing, see the relative table for the meaning of the signal.

signal LED	error	meaning and solution
red LED flashing	Batteries flat start copy	The batteries are flat, the copy cannot be made. Replace the batteries (only for PSOPZKEY00).
Green LED flashing	Batteries flat copy end (only for PSOPZKEY00)	The copy operation has been performed correctly but at the end of the operation the battery voltage is low.
Flashing simultaneously red/green LED (signal orange)	Instrument not compatible	The parameters set-up cannot be copied because the controller model connected is not compatible. This error only for DOWNLOAD function, check the controller code and copy only onto compatible codes.
Red and green LEDs on	Copy error	Error in the data copied. Repeat the operation, if the problem persists, check the batteries and key connections.
Red LED on stable	Data transfer error	The copy operations has not terminated due to serious data transfer or copy errors. Repeat the operation, if the problem persists, check the batteries and key connections.
LEDs off	Batteries disconnected	Check batteries (for PSOPZKEY00)
	Power supply unit not connected	Check power supply unit (for PSOPZKEYA0)

3. USER INTERFACE

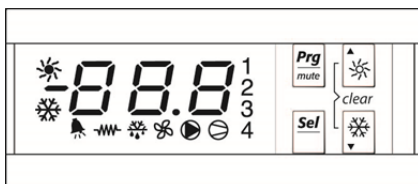

The front panel contains the display and keyboard, made up from 4 keys, which, pressed individually or together, allow to perform all of the controller programming operations.

3.1 Display

The display features 3 digits, with the display of the decimal point between -99.9 and 99.9. Outside of this range of measurement, the value is automatically displayed without the decimal (even if internally the unit still operates considering the decimal part). In normal operation, the value displayed corresponds to the temperature read by probe B1, that is, the evaporator water inlet temperature*. During the programming it shows the codes of the parameters and their value.

(*) Viewing of the standard display can be changed via parameter b00.

Icon	Colour	Meaning	
		With LED on	With LED flashing
1, 2	Amber	Compressor 1 and/or 2 on	Start up request
3, 4	Amber	Not used	Not used
	Amber	At least 1 compressor on	-
	Amber	Condenser pump/fan on	Start up request
	Amber	Condenser fan active	-
	Amber	Not used	Not used
	Amber	Heater on	-
	Red	Alarm on	-
	Amber	Not used	Not used
	Amber	Chiller mode	Chiller mode request

3.2 Keypad

Key	Machine state	Pressure mode
Prg <i>mute</i>	Loading default values Return to upper level up to exit (with saving in EPROM)	Controller power supply with key pressed Single press
Sel	Access to parameters type "Direct" Selection and display of type "Direct" parameter value Confirm parameter value variation	Single press
Prg <i>mute</i> + Sel	Parameters programming via introduction of password	Press for 5 s
(UP)	Value increase Selection of successive parameter Immediate access to values read by the probes (parameters b01, b02,...) Passage from stand-by to chiller mode and vice versa	Single or continuous press Single of continuous press Single press Press for 5 s
(DOWN)	Value decrease Select previous parameter Immediate access to values read by the probes (parameters b01, b02,...)	Single or continuous press Single press
+	Alarms manual reset Immediate timer reset	Press for 5 s

3.3 Example: timer reset



Pressing e simultaneously, in the timer value display phase (e.g. parameter c10), resets the same at zero and consequently cancels the maintenance request.

3.4 Programming

The parameters divide into 4 different levels according to their accessibility by the user via password and their function. Entering a certain level it is possible:

1. to access all parameters of the same level and the lower levels (S-P menu);
2. set the desired level for each parameter (L-P menu).

Levels

“Factory”: accessible with password 66, it allows the configuration of all unit parameters;

“Super User”: accessible with password 11, it allows the configuration of the Super User, User and Direct parameters;

“User”: accessible with password 22, it allows the configuration of those parameters that can be set typically by the user and Direct, therefore relative to the options.

“Direct”: accessible by pressing “Sel” for 5 s, it allows to read the probes and any data, which can be interrogated by anyone without compromising unit operation.

Default parameters setting

To enable the setting procedure for parameters at default values (controller power supply with **Prg** pressed) set the parameter H22 = 1.

Par.	Description	Def	Min	Max	U.M.
H22	Default parameters setting 0/1 = enabled/disabled	0	0	1	-

1. Press “**Prg**” and “**Sel**” for 5 s;
2. The and symbols appear along with “00”;
3. Set the password via “” and “” and confirm with “**Sel**”;
4. Select the parameters menu (S-P) via “” and “”. Confirm with “**Sel**”;
5. Select the parameters category (A,b,c,d..) via “” and “”. Confirm with “**Sel**”;
6. Select the parameter via “” and “”. Confirm with “**Sel**”;
7. Modify the parameter value with “” and “”.
8. After modification, press “**Sel**” to confirm or “**Prg**” to annul the modification;
9. Press “**Prg**” to return to the previous menu;
10. To save the modifications, press “**Prg**” several time until going back to the main menu.

Notes:

1. the parameters modified without confirmation via the “**Sel**” key go back to the previous value;

2. if no operations are performed on the keyboard for 60 seconds, the controller exits the parameter modification menu by timeout and the changes are cancelled.

3. to modify the level of a parameter, enter the levels menu L-P and assign the desired level to each parameter.

3.5 Menu structure

The figure shows the categories of the parameters that can be selected during programming.

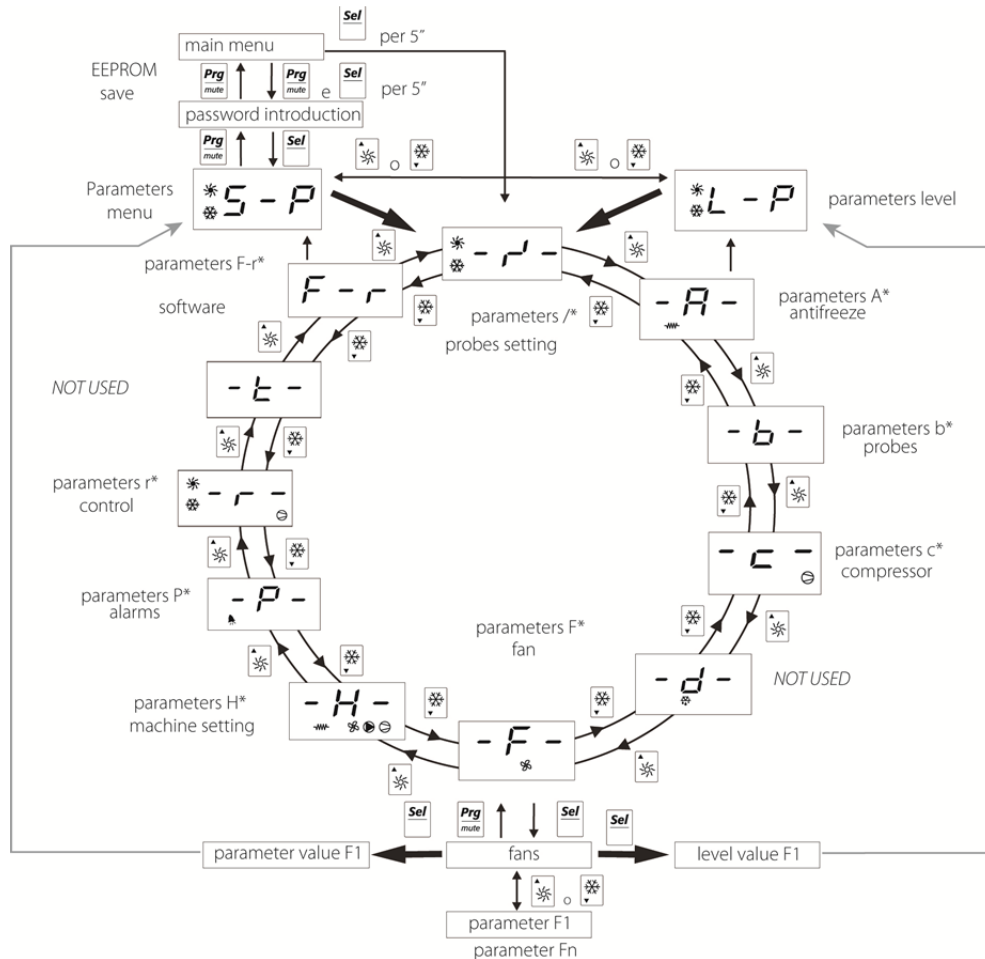

4. COMMISSIONING

4.1 Firmware version

On controller switch-on the firmware version of the same can be verified, along with that of the EVD⁴ driver and I/O expansion board via the parameters H99, H97 and H95.

Par.	Description	Def	Min	Max	U.M.
H99	Software version	-	0	99.9	-
H97	Driver software version	-	0	999	-
H95	Expansion board I/O software version	-	0	99.9	-

4.2 Configuration

The configuration parameters must be set during the commissioning of the controller and concern:

- the type of chiller: air-water or water-water, number of compressors and partialisation logic, enabling of compressor partialisation in high pressure mode, enabling hot gas and pump down by-pass function;
- the configuration of the tLAN network: devices connected, type of protocol and serial address;
- the setting of the device counter, the keyboard block, the modification of the alarm relay state.

Machine parameters (par. H01, H04, H05, H12, H25, H26)

The controller allows to manage two types of chiller: air-water and water-water. Moreover, the number of compressors per circuit can be 1 or 2 with alternating operation (tandem) or compressor 1 with partialisation valve, powered according to the logic of parameter H12. Rotation is not managed in this case (see the "Regulation" chap.). The hot gas by-pass in temperature mode function allows to increase the temperature of the output water from the evaporator. See the regulation chapter.

Par.	Description	Def	Min	Max	U.M.
H01	Chiller type 2=Air-water 4=Water-water	2	2	4	-
H04	Number of compressors per circuit 0 = 1 compressor on circuit 1 1 = 2 compressors tandem on circuit 1 2 = Do not select 3 = Do not select 4 = 1 compressor and a partialisation on circuit 1 5 = Do not select	0	0	5	-
H05	Evaporator pump 0=Absent 1=Always on 2=On at regulator request 3=On at regulator request and timed	1	0	3	-
H12	Compressor partialisation valve 0 = Normally excited 1 = Normally unexcited 2, 3 = Do not select	1	0	3	-
H13	Pump down 0/1 = disabled/enabled	0	0	1	-
H25	Hot gas by-pass 0/1 = disabled/enabled	0	0	1	-
H26	Hot gas by-pass in stand-by 0/1 = disabled/enabled	0	0	1	-

Network parameters (par. H08, H10, H23)

The tLAN network can be composed just by the controller for process chiller, which will have the inputs/outputs for the standard machine controller. If the thermostatic expansion valve is replaced by the electronic expansion valve, the EVD⁴ driver must be connected. If connected, the I/O expansion board allows to configure the digital inputs with 5 new warnings or alarms. Moreover, it allows each individual digital output to change on the basis of an individual alarm. The serial address identifies the controller in a RS485 network with Carel or Modbus protocol.

Par.	Description	Def	Min	Max	U.M.
H08	Network configuration 0 = Control only 1 = Control + EVD 2, 3 = Do not select 4 = Control + IO 5 = Control + EVD + IO 6, 7 = Do not select	0	0	7	-
H10	RS485 serial address	1	1	200	-
H23	Network protocol 0 = Carel 1 = ModBus	0	0	1	-

tLAN address configuration

The tLAN factory addresses of the I/O expansion board and of the EVD⁴ driver are given in the table. The tLAN address of the I/O expansion board is fixed. To modify the address of the EVD⁴ driver, consult the manual cod +03022027.

Device	tLAN address
I/O expansion board	3
EVD ⁴ Driver	2

Other configuration parameters (par. c14, /23, H09, P35)

c14 establishes the number of operating hours of the compressors/pumps, expressed in hundreds of hours, over which to activate the maintenance request signal (Hc1, Hc2). c10 and c11 are read only parameters and indicate the number of operating hours of the compressors 1 and 2, expressed in hundreds of hours. c15 and c16 are read only parameters and they indicate the number of evaporator and condenser pump operating hours, expressed in hundreds of hours. The maintenance request signal for the pumps is always Hc1. Pressing \star and \downarrow simultaneously, in the timer value display phase, resets the same at zero and consequently to the cancellation of the maintenance request. H09 allows to disable the modification of the "Direct" and "User" parameters from keyboard; however it allows to display the parameter values. The timer reset function is also disabled. P35 allows to alter the status of the alarm relay, if it is active.

Par.	Description	Def	Min	Max	U.M.
c10	Compressor 1 timer	0	0	800	100 h
c11	Compressor 2 timer	0	0	800	100 h
c14	Maintenance request threshold 0 = function disabled	0	0	100	100 h
c15	Evaporator pump timer	0	0	800	100 h
c16	Condenser pump timer	0	0	800	100 h
/23	Unit of measurement: 0/1 = °C/°F	0	0	1	-
H09	Lock keypad: 0/1 = disabled/enabled	1	0	1	-
P35	Modify alarm relay status via PRG/mute: 0/1=No/Yes	0	0	1	-

4.3 Minimum and maximum fan speed calculation

This procedure should only be performed when the fan speed control boards are used (code MCHRTF*). When ON/OFF modules are used (code CONVONOFF0) or alternatively the PWM to 0 to 10 V converters (code CONV0/10A0) are used, parameter F03 should be set to zero, and parameter F04 to the maximum value. Given the different types of motors existing on the market, it must be possible to set the voltages supplied by the circuit board corresponding to the temperatures of minimum and maximum speeds. In this regard (and if the default values are not suitable), proceed as follows:

- set the parameter F02=0 and reset F03 and F04 to zero;
- the condensation set point has been modified to take the output signal to the maximum value (PWM);
- increase F04 until the fan operates at a sufficient speed (make sure that, after having stopped it, it can rotate freely when released);
- "copy" this value to parameter F03; this sets the voltage for the minimum speed;
- connect a voltmeter (set to AC, 250V) between the two "L" terminals (the two external contacts);
- increase F04 until the voltage stabilises at around 2 Vac (inductive motors) or 1.6, 1.7 Vac (capacitive motors);

Once the value has been found, it will be evident that even when increasing F04 the voltage no longer decreases. Do not increase F04 further so as to avoid damaging the motor;

- restore the correct condensation set point.

The operation is now completed.

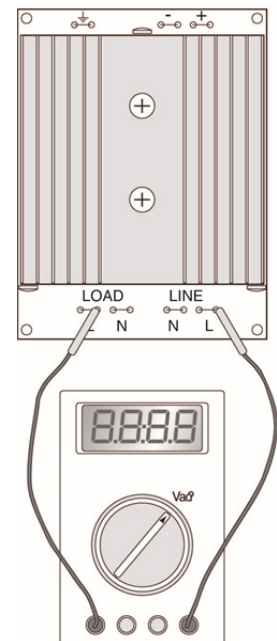

5. FUNCTIONS

5.1 Set point

The control algorithm is the ON/OFF type according to the figure. The set point r01 can be set from a minimum value to a maximum value (par. r13, r14). The probe selected for the control depends on parameter r06, once enabled with the parameters /01 and /02. If r06 = 0, 1 the probe is B1. If r06 = 2, 3, 4 the control probe is B2. A second set point value can be set from external digital input (par. r21). Instead, setting B3 or B4 as differential control probe, the relative set point control is activated, in which the set point becomes r01 plus the value read by probe B3 or B4.

Par.	Description	Def	Min	Max	U.M.
r01	Set point	12	r13	r14	°C/°F
r02	Differential	3	0,1	50	°C/°F
r06	Type of regulation/compressors use 0 = Proportional input 1 = Proportional input + neutral zone 2 = Proportional output 3 = Proportional output + neutral zone 4 = Timed output with neutral zone	0	0	4	-
r13	Minimum set point	-40	-40	r14	°C/°F
r14	Maximum set point	80	r13	176	°C/°F
r21	Set point from external contact	12	r13	r14	°C/°F
r45	Relative control maximum set point	30	r46	176	°C/°F
r46	Relative control minimum set point	10	-40	r45	°C/°F
r47	Switch-off Differential of compressor for low temperature	1.0	0.1	10	°C/°F
P08/P09/P34	Digital input selection ID1/ID2/ID5 13=2 nd Set point	0	0	23	-

Valido solo se H25=1.

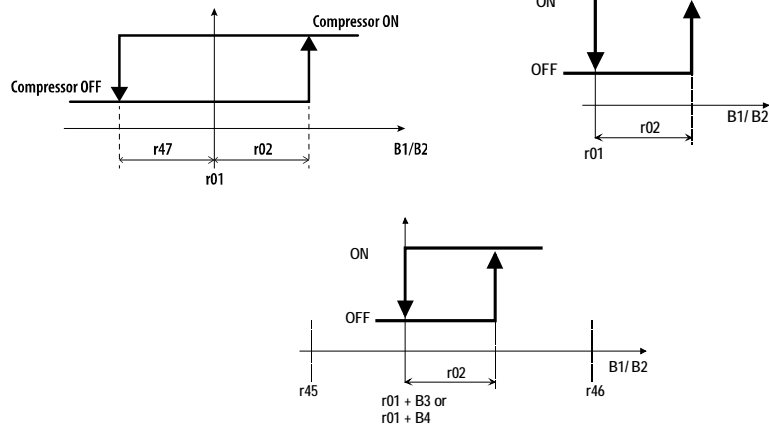

Key	
r01	Set point
r02	Differential
r47	Switch-off Differential of compressor for low temperature, if H25 = 1
B1/B2	Evaporator input/output probe
B3/B4	Differential control probe

For the explanation of the functions relative to the compressors, see par. 6.4.7.

5.2 Probes (analogue inputs)

The probe parameters allow to:

- set the type and function of the probe;
- set the offset for the correction of the reading (calibration);
- set the maximum/minimum voltage input;
- activate a filter to stabilize the measurement.

Par.	Description	Def	Min	Max	U.M.
/01	Probe B1: 0/1 = Absent/present	1	0	1	-
/02	Probe B2: 0/1 = Absent/present	1	0	1	-
/03	Probe B3: 0 = Absent 1 = Condenser NT 2 = External NTC 3 = Differential control	0	0	3	-
/04	Probe B4: 0 = Absent 1 = Digital input 2 = External NTC 3 = Ratiometric Condenser 4 = Differential control	0	0	4	-
/09	Minimum voltage input value	50	0	/10	Vdc/100
/10	Maximum voltage input value	450	/09	500	Vdc/100
/11	Minimum pressure value	0	0	/12	bar
/12	Maximum pressure value	34,5	/11	99,9	bar
/13	Probe B1 calibration	0	-12	12	°C/°F
/14	Probe B2 calibration	0	-12	12	°C/°F
/15	Probe B3 calibration	0	-12	12	°C/°F
/16	Probe B4 calibration	0	-12	12	°C/°F/ bar
/21	Digital filter	4	1	15	-
/22	Input limitation	8	1	15	-

The probes B1/B2 have the function of input/output evaporator temperature. The probe B3 can be configured as condensation temperature probe, external or differential control. The external probe allows the activation of the external compensation algorithm. The probe B4 can have the same functions as B3 and in addition acts as digital input (can be configured from par. P13). In this case, the condenser probe is ratiometric. Parameters /09, /10, /11, /12 establish the work range of the ratiometric probe.

Example:

Input 0...4.5 Vdc on B4, /09=0, /10 = 4.5 V dc, /11 = 5, /12 = 10, /16=0

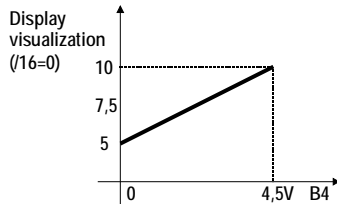

Therefore 5 will be displayed in correspondence with 0 V and 10 will be displayed in correspondence with 4.5 V. These are also the values on the basis of which control takes place.

The parameters /13.../16 allow to correct the measurement shown on the display, adding an offset of the measurement read by the probe: the value assigned to this parameter is added to the probe if positive or removed if negative.

The parameter /21 allows to establish the coefficient used in digital filtering of the value measured. High values of this parameter allow to eliminate any continuous interference at the analogue inputs (but reduces measurement immediacy). The

5.3 Probe reading

b00 allows to set the probe for standard display viewing.

b01...b04 are the values read by the probes B1...B4.

Par.	Display	Def	Min	Max	U.M.
	0 = Probe B1 2 = Probe B3 4, 5, 6 = Do not select 9 = Set point with compensation	1 = Probe B2 3 = Probe B4 8 = Set point without compensation 10 = ID remote			
b00	Probe B1 reading		0	11	-
b01	Probe B2 reading		0	0	°C/°F
b02	Probe B3 reading		0	0	°C/°F
b03	Probe B4 reading		0	0	°C/°F
b04	Display 0 = Probe B1 2 = Probe B3 4, 5, 6 = Do not select 9 = Set point with compensation	1 = Probe B2 3 = Probe B4 8 = Set point without compensation 10 = ID remote 11 = Do not select	0	0	°C/°F/bar

EVD⁴ driver probes reading

The following displays appear only if an external EVD⁴ driver is connected, which transmits them to the controller via tLAN.

b09: driver evaporation temperature.

b10: driver evaporation pressure: value measured of the evaporation pressure.

b11: driver superheating = superheated gas temperature – evaporation saturate temperature.

b12: saturation temperature = value calculated of the evaporation saturate temperature.

b13: valve position as %.

b19: condenser output temperature probe.

Par.	Description	Def	Min	Max	U.M.
b09	Driver evaporation temperature	0	0	0	°C/°F
b10	Driver evaporation pressure	0	0	0	bar
b11	Driver overheating	0	0	0	°C/°F
b12	Driver saturation temperature	0	0	0	°C/°F
b13	Driver valve position	0	0	100	%
b19	Condenser output temperature probe	0	0	0	°C/°F

5.4 Digital inputs

The inputs ID1...ID5 refer to the µC²SE controller. The inputs ID11...ID15 refer to the I/O expansion board. The analogue input B4 can be configured as digital input (par. P13). The following digital inputs cannot be configured (see wiring diagram):

ID3	High pressure alarm input
ID4	Low pressure alarm input

Regarding the alarm inputs, see the “Alarms” chapter.

P08: as well as the flow switch/pump thermal overload/general alarms with manual or automatic reset, it is possible to configure the digital input for: the set point change from r01 to r21, limited by parameters r13 and r14 (minimum and maximum set-point); On/Off remote. Enabling is given by parameter H07.

P37: the digital inputs 11...15 of the I/O expansion board can be configured as:

warning input Ad1...Ad5: causes only Ad1...Ad5 shown on display;

alarm input Ad1...Ad5: causes the display of Ad1...Ad5 and unit switch-off.

The warnings/alarms Ad1...Ad5 can be used to switch-over the outputs NO11,...NO15 of the I/O expansion board, along with the high pressure, low pressure alarms, etc. See parameter P42 at the "Digital outputs" paragraph.

Par.	Description	Def	Min	Max	U.M.
P08	Digital input 1 0=Not used 1=Flow switch alarm with manual reset 2=Flow switch alarm with automatic reset 3=General thermal overload alarm with manual reset 4=General thermal overload alarm with automatic reset 7=Thermal overload alarm with manual reset 6=Thermal overload alarm with automatic reset 7, 8, 9, 10 = Do not select 11=General alarm with manual reset 12=General alarm with automatic reset 13=2° Set-point 14...22=Do not select 23=On/Off remote	0	0	23	-
H07	Digital input On/Off: 0/1=Absent/present	0	0	1	-
r13	Minimum set point	-40	-40	r14	°C/°F
r14	Maximum set point	80	r13	176	°C/°F
r21	Set-point from external contact	12	r13	r14	°C/°F
P09	Digital input 2 - See P08	0	0	23	-
P13	Configuration of B4 as digital input if /4=1 - See P08	0	0	23	-
P34	Digital input 5 - See P08	0	0	23	-
P37	Digital input 11: 0 = not connected; 1...5 = Alarm Ad1...Ad5; 6...10 = Warning Ad1...Ad5	0	0	10	-
P38	Digital input 12 - See P37	0	0	10	-
P39	Digital input 13 - See P37	0	0	10	-
P40	Digital input 14 - See P37	0	0	10	-
P41	Digital input 15 - See P37	0	0	10	-

5.5 Digital outputs

Regarding the alarm outputs configuration, see the "Alarms" chapter. The following digital output cannot be configured.

Parameter H11 allows associating the digital outputs to the unit actuators (see table). The function of the other digital outputs can be configured from parameter.

H11

	0	1	2	3	4	5	6
NO1	compressor 1	compressor 1	compressor 1	compressor 1	compressor 1	compressor 1	compressor 1
NO2	heater 1	heater 1	heater 1	-	-	heater 1	heater step 1
NO3	evaporator pump	evaporator pump	evaporator pump	evaporator pump	evaporator pump	evaporator pump	-
NO4	-	compressor 2 (or compressor 1 partialization)	compressor 2 (or compressor 1 partialization)	compressor 2 (or compressor 1 partialization)	compressor 2 (or compressor 1 partialization)	condenser fan	-
NO5	alarm	alarm	-	alarm	alarm	alarm	alarm

	7	8	9	10	11	12
NO1	compressor 1	compressor 1	compressor 1	compressor 1	compressor 1	compressor 1
NO	heater step 1	heater 1 step	compressor 2	compressor 2	compressor 2	P25
NO3	-	-	-	-	-	P26
NO4	heater step 2	condenser fan	-	heating step 1	heating step 1	P27
NO5	alarm	alarm	alarm	alarm	alarm	P28

To change the function of the other outputs, operate on the following parameters.

Par.	Description	Def	Min	Max	U.M.
P21	Alarm relay output logic: 0/1=Normally unexcited/excited	0	0	1	-
P25	Digital output 2 0 = No function 1 = Compressor 2 2 = Anti-freeze heater/support 1 3 = Do not select 4 = Pump/condenser fan 5, 6, 7 = Do not select 8 = Condenser fan on/off 9 = Anti-freeze heater/support 2 10 = Alarm 11 = Do not select	0	0	11	-
P26	Digital output 3 - See P25	0	0	11	-
P27	Digital output 4 - See P25	0	0	11	-
P28	Digital output 5 - See P25	0	0	11	-
P42	Digital output 11 0 = Not used 1...5 = Ad1...Ad5 6 = High pressure alarm 7 = Do not select 8 = Low pressure alarm 9 = Do not select 10 = Circuit 1 thermal overload 11 = Do not select 12 = Flow switch alarm 13 = Low temperature alarm 14 = High temperature alarm 15 = Low temperature alarm at start-up 16 = High temperature alarm at start-up 17 = Pump overload 18 = Do not select 12 = Flow switch alarm	0	0	18	-
P43	Digital output 12 - See P42	0	0	18	-
P44	Digital output 13 - See P42	0	0	18	-
P45	Digital output 14 - See P42	0	0	18	-
P46	Digital output 15 - See P42	0	0	18	-

5.6 Analogue outputs

The analogue output Y1 is set-up for the condenser fan and is active if F01 = 1. In systems with hot gas bypass function enabled, the bypass valve is commanded by the output Y1 (controller) or Y2 (I/O expansion board). See the control chapter.

5.7 Compensation

The compensation can indifferently increase or decrease the value of r01 depending on whether r17 is respectively positive or negative.

r01 varies only if the external temperature (e.g.B3) exceeds r19:

if B3 is over r19 there will be: $r01 \text{ effective} = r01 + (B3-r19)*r17$

if B3 is lower than r19: $St1 \text{ effective} = St1$

Par.	Description	Def	Min	Max	U.M.
r01	Set-point	12	r13	r14	°C/°F
r17	Compensation constant: 0 = no compensation	0	-5	5	-
r18	Maximum distance from the set-point	0,3	0,3	20	°C/°F
r19	Start compensation temperature	30	-40	176	°C/°F

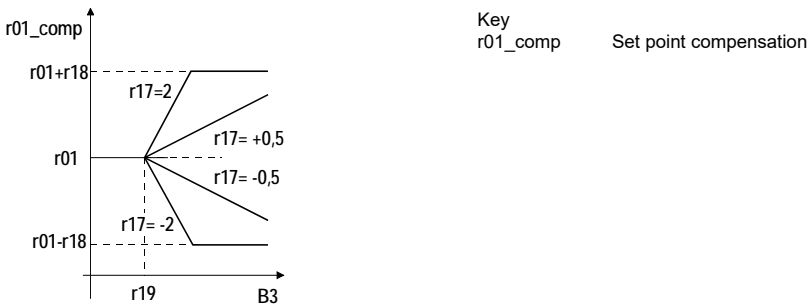

5.8 Low load

In the systems with reduced water content, a storage tank must be provided, so that there are no continuous and rapid temperature changes in the cooled water following control intermittence. In this way, the number of compressor hourly switch-ons/off is limited to an acceptable number. The storage tank can be eliminated in low load conditions.

Low load condition:

1. only one compressor is active;
2. the compressor is switched off after an operating period less than the value of parameter r28.

r28 therefore represents the minimum operating time of the compressor, below which the low load condition is determined. The compressor will analyse the low load status every time the compressor is switched off. If already in low load state, the time considered by the controller for the new analysis becomes $r28 \times r29$.

The low load differential is r29. This parameter represents the new differential considered by the controller during the low load condition. Specifically r02 is replaced by r29.

Par.	Description	Def	Min	Max	U.M.
r27	Accumulation vessel suppression (low load) 0=Disabled 1=Enabled 2=Do not select 3=Do not select	0	0	3	-
r28	Min. compressor running time for low load	60	0	999	s
r29	Low load differential	3	1	50	°C/°F

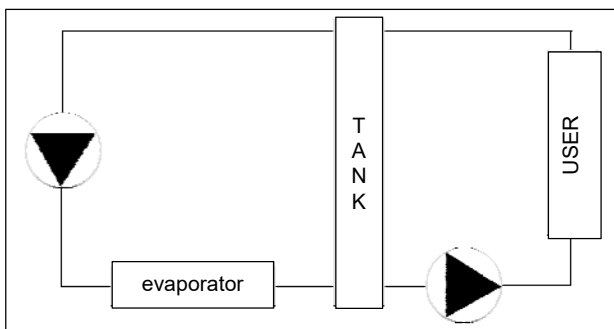

6. CONTROL

6.1 Anti-freeze

The anti-freeze probe is B2. The anti-freeze set-point A01 represents the temperature below which the machine passes to anti-freeze mode: alarm A1 activates and switches the alarm output. The value of A01 is limited by A07. A03 is the intervention delay time of the anti-freeze alarm when starting the machine.

Par.	Description	Def	Min	Max	U.M.
A01	Anti-freeze alarm set-point	3	A07	A04	°C/°F
A07	Anti-freeze alarm set-point limit	-40	-40	176	°C/°F
A02	Anti-freeze alarm differential	5	0.3	122	°C/°F
A03	Anti-freeze alarm delay time from switch-on	0	0	150	s

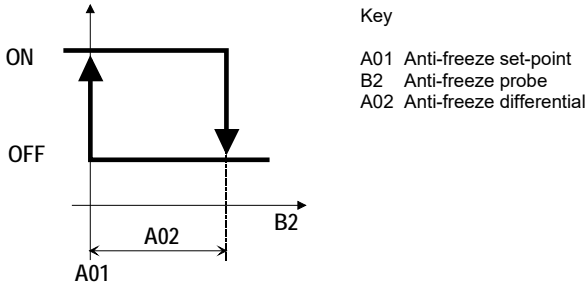

6.2 Anti-freeze automatic switch-on

The parameter A10 has effect if the unit is in stand-by.

A10 = 1: auxiliary heater (if enabled) and pump are on at the same time on the basis of the set point A04;

A10 = 2: do not select;

A10 = 3: heaters only on, on the basis of the set point A04.

Par.	Description	Def	Min	Max	U.M.
A10	Anti-freeze automatic switch-on 0 = Disabled 1 = Heaters and pumps on simultaneously on A4 2 = Do not select 3 = Heaters on at A4	0	0	3	-

6.3 Anti-freeze with EVD⁴

With the EVD⁴ driver connected, A14 represents the evaporation temperature transmitted by the driver, below which the anti-freeze alarm is activated; when the alarm is active, the compressors in the circuit affected are switched off, while the pump remains on to reduce the possibility of freezing. Reset (manual or automatic, see par. P05) only occurs when the water temperature exceeds A14+A02

Par.	Description	Def	Min	Max	U.M.
A14	Anti-freeze EVD ⁴ alarm set point	3	A07	A04	°C/°F
A02	Anti-freeze alarm differential	5	0,3	122	°C/°F

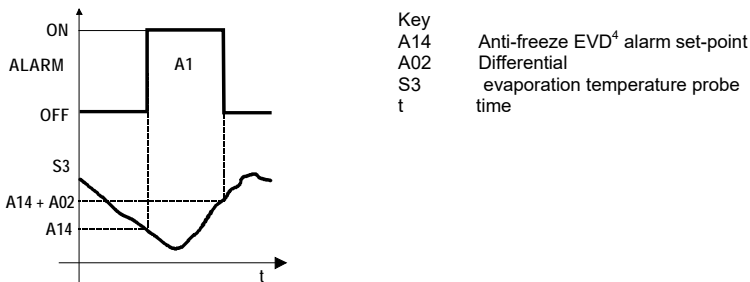

6.4 Compressors management

Digital outputs at relay (par. c01, c02, c03, c04, c05)

The parameters in question regard the minimum operating times or switch-off times of the same output or different outputs, with the purpose of protecting the compressor and preventing regulation oscillations.

⚠ For the times set to become operational, switch the controller off and back on again after programming.

Protection for the output at relay (par. c01, c02, c03)

c01 establishes the minimum activation time of the output, independently from request. c02 establishes the minimum switch-off time if the output, independently from request. c03 establishes the minimum time between two successive switch-ons of the same output.

Par.	Description	Def	Min	Max	U.M.
c01	Compressor minimum switch-on time	60	0	999	s
c02	Compressor minimum switch-off time	60	0	999	s
c03	Delays between switch-ons of the same compressor	360	0	999	s

Protection for outputs with different relays (par. c04, c05)

c04 establishes the minimum time that must pass between successive switch-ons of 2 compressors. By delaying the connection, line overloads are prevented due to close or simultaneous peaks, c05 establishes the minimum time that must pass between the switch-off of the two compressors.

Par.	Description	Def	Min	Max	U.M.
c04	Switch-on delay between 2 compressors	10	0	999	s
c05	Switch-off delay between 2 compressors	0	0	999	s

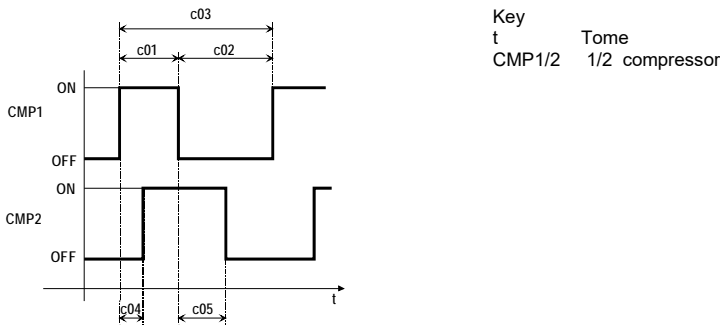

Maximum operating time of compressor in tandem (par. c09)

In the case of 2 tandem compressors, it must be prevented that a compressor of the same circuit works over the time set (c09), if the other remains off. This to prevent the oil in common from migrating over that allowed towards the active compressor, thus preventing that the next start-up of the compressor remaining unused (FIFO logic) causes serious problems due to poor lubrication. Therefore the compressor 1 (or 2), if it must operate continuously, after time c09 will switch off leaving the task to the other, which was off. This function considers the compressor protections. A c09 value lower than a c03 value is ignored and the compressors exchange after time c03.

Par.	Description	Def	Min	Max	U.M.
c09	Maximum operating time of compressor in tandem - 0 = function disabled	0	0	60	min

Compressor partialization in high pressure mode (par. P04)

The parameter enables or disables partialisation of the circuit in high pressure mode. The function is valid if the unit is provided with tandem or partialized compressors and pressure transducers. In the event of a high pressure alarm, i.e. values over P18 (with hysteresis of 0.5 bar), the controller disables one power step of the circuit of interest and waits for 10 seconds. When this interval has expired, if the alarm is still active, the unit is stopped otherwise it continues to operate in partialised mode. In this condition, the indication PH1 is displayed. This condition remains active while the pressure does not drop below the value corresponding to the maximum condenser fan speed (F05+F06). The unit re-enables the power step below this limit.

Par.	Description	Def	Min	Max	U.M.
P04	Enabling of compressor partialisation in high pressure mode 0=Deactivated 1=Activated 2=Do not select 3=Do not select	0	0	3	-

Compressors rotation (par. r05)

The rotation of the compressors allows the operating hours to be balanced either statistically, using FIFO logic, or absolutely, by counting the effective operating hours.

Settings:

r05=0: rotation disabled. The customer can use compressors with different power ratings according to the desired logic or manage the partialisation, activating/deactivating them in proportional mode.

r05=1: rotation with FIFO logic for switch-on/off (the first to be switched on will be the first to be switched off and vice versa). In this way the operating hours will be optimised along with the compressor peaks, even if the compressor times will always be respected.

r05=2: rotation with hours control. The compressors will have the same operating hours, as the compressor with the least operating hours is always started first, again observing the safety times. This does not however consider FIFO logic and does not optimise the starts and stops;

r05=3: do not select.

Par.	Description	Def	Min	Max	U.M.
r05	Compressors rotation 0 = Disabled 1 = FIFO type 2 = Hours balancing 3 = Do not select	0	0	3	-



Note: the FIFO or timed rotation logic is not valid in the event of compressor partialised output.

Regulation type/ compressor use (r06, r07)

r07: neutral zone. The neutral zone moves the proportional band by r07 from the set-point and is valid in all configurations, if enabled by param.r06.

r06: compressors regulation type. This parameter allows to set the logic for maintenance of the set-point.

Par.	Description	Def	Min	Max	U.M.
r06	Type of regulation/compressors use 0 = Proportional Input 1 = Proportional Input + neutral zone 2 = Proportional output 3 = Proportional Output + neutral zone 4 = Timed output with neutral zone	0	0	4	-
r07	Neutral zone differential	2	1	50	°C/°F

r06 = 0: proportional input

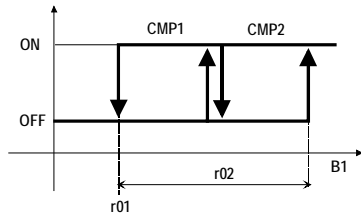
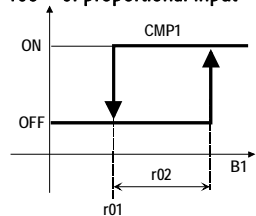

r06 = 2: proportional output

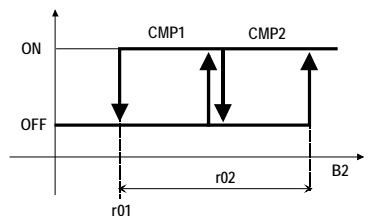
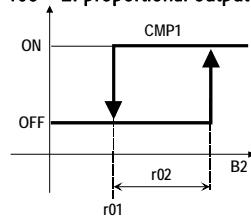

r06 = 1: proportional input + neutral zone

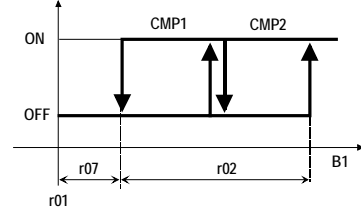
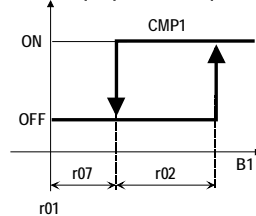

r06 = 3: proportional output + neutral zone

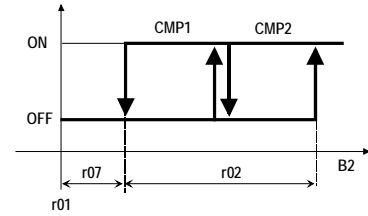
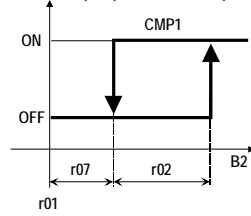

Key
 r01 Set point t
 r02 Differential B1
 Time
 Evaporator input probe
 r07 Neutral zone differential
 B2 Evaporator output probe
 CMP1/2 1/2 compressor

Timed output with neutral zone (r06 = 4)

This type of regulation originates from the requirement to keep the output temperature as constant as possible, in spite of the fact that the load is variable, or the system inertia is reduced. The logic has the objective of maintaining the temperature inside the neutral zone. If outside, the compressors are activated with the logic described below, to return to neutral area, not too quickly (with integral or derivative action) or too slowly (with fixed time logic). 2 logic times are considered:

- activation time
- deactivation time.

Activation/deactivation time

Par.	Description	Def	Min	Max	U.M.
r01	Set point	12	r13	r14	°C/°F
r02	Differential	3	0.1	50	°C/°F
r06	Type of regulation/compressors use: 0 = Proportional input 1 = Proportional input + neutral zone 2 = Proportional output 3 = Proportional output + neutral zone 4 = Timed output with neutral zone	0	0	4	-
r07	Neutral zone differential	2	0.1	50	°C/°F
r08	Output maximum activation time	120	0	999	s
r09	Output minimum activation time	100	0	999	s
r10	Output maximum deactivation time	120	0	999	s
r11	Output minimum deactivation time	100	0	999	s
r12	Compressors deactivation differential	2	0	50	°C/°F

Activation time

The activation time is not a set parameter, but a value between 2 selected parameters, i.e r08 and r09. As soon as the neutral zone is exited, the activation time is practically r08, while at differential end r02 the activation time is r09. Within the differential r02, the activation time varies in a linear mode between r08 and r09. This means as you move away from the set, the intervention times are reduced, in order to make the system response more dynamic.

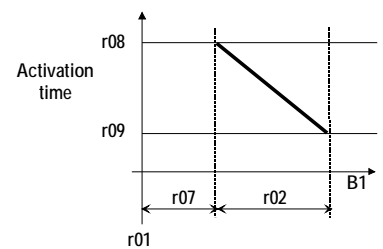

De-activation time

In the same way as the activation time, the deactivation time also varies depending on a maximum, i.e. the value set by the parameter r10 in correspondence of the set point temperature and a minimum, determined by parameter r11, in correspondence with the differential end for the deactivation of compressors in this mode, selected via parameter r12. Below this value the deactivation time will be the same as the minimum set to the temperature value A04, beyond which all compressors will be switched off, irrespective of times. On moving away from the set point, a more dynamic process reaction is derived.

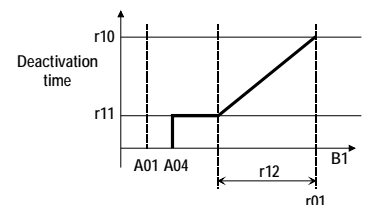

Outputs activation delay (par. c06)

On switch-on (intended as physical power supply of the controller), the activation of all outputs is delayed by the time set to distribute the absorptions and protect the compressor from repeated switch-ons in the event of frequent power-cuts. This means that, after this delay period, the controller will start to manage the outputs on the basis of the protections and the normal operations functions.

Par.	Description	Def	Min	Max	U.M.
c06	Outputs activation delay	0	0	999	s

Compressors deactivation external temperature (par.r25)

The compressors are deactivated if the external temperature drops below the value of r25. The differential for re-activation is fixed at 1 degree. The resistances can be activated according to the relative set-points

Par.	Description	Def	Min	Max	U.M.
r25	Compressors deactivation external temperature -40 = function deactivated	-40	-40	80	°C/°F

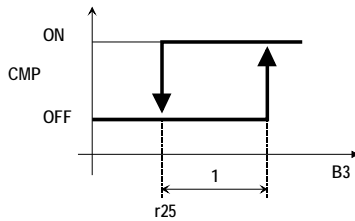

Key:
CMP = Compressore
B3 = Probe esterna

6.5 Pumps management

Pump operation

H05 establishes the evaporator pump operating mode.

H05 = 0: pump disabled, (the flow switch alarm is ignored)

H05 = 1: always on (alarm managed)

H05 = 2: switched-on on regulator request (alarm managed)

H05 = 3: pump activated at regular ON and OFF intervals (with compressor in OFF) according to parameters c17 and c18.

Minimum switch-on/off times

c17: below find the operating diagram of the pump in burst mode (active with H05 = 3). The burst operation is disabled in stand-by and during an alarm with pump inhibited. On switch-on it is activated after time c17. c18 represents the minimum time during which the pump remains active. See the following paragraph for compressor-pump delays c07 and c08.

Par.	Description	Def	Min	Max	U.M.
c17	Pump minimum switch-off time	30	0	150	min
c18	Pump minimum switch-on time	3	0	15	min

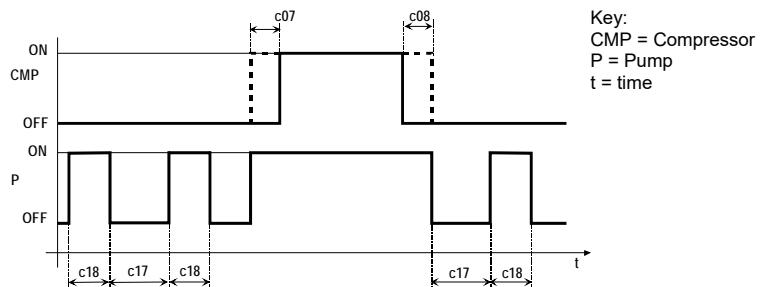

Key:
CMP = Compressor
P = Pump
t = time

6.6 Compressor – evaporator pump/valve delays

Compressor-pump delays (par. c07, c08)

c07: if the evaporator pump is on at request of the regulator (H05 = 2), if necessary, the compressor is enabled after the time set. If the pump is always on (H05 = 1) it is activated after the times set by unit switch-on (c06).

c08: with the pump on by regulator call (H05=2), in the event of compressor switch-off, regulation first pilots compressor deactivation and then that of the pump. If the flow pump is always on (H05=1), it is only deactivated in standby.

Par.	Description	Def	Min	Max	U.M.
c07	Pump-compressor switch-on delay	20	0	999	s
c08	Compressor-pump switch-off delay	1	0	150	min

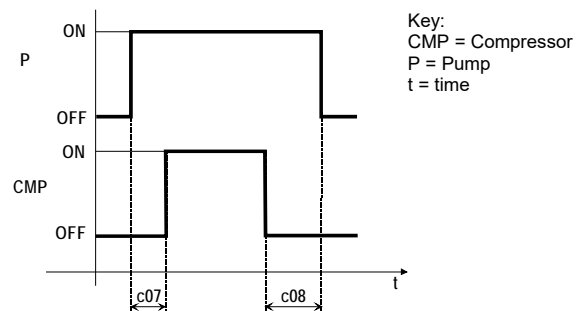

Key:
CMP = Compressor
P = Pump
t = time

Valve-compressor switch-on delay

c19 represents the delay time necessary to ensure that the valve opens before compressor start-up. The parameter is only available when the EVD⁴ driver is connected.

Par.	Description	Def	Min	Max	U.M.
c19	Valve-compressor switch-on delay	3	0	100	s

6.7 Fan management

Fan operation

F01 enables the condenser fan output, according to the output assigned by parameter H11. Depending on the type of fan, the controller PWM output (Y1), always active, requests the presence of optional boards:

- 1) CONVONOFF0 for the conversion of the PWM output into ON/OFF output;
- 2) CONV0/10A0 for the conversion of the PWM output into 0...10 Vdc or 4...20 mA output;
- 3) optional phase cut boards MCHRTF*/FCS (supplied with Triac). In this case, it is necessary to specify the voltages supplied by the Triac to the fan electric motor, corresponding to minimum and maximum speed. The value set does not correspond to the rms voltage (in Volts) applied but to a calculation unit inside the $\mu\text{C}^2\text{SE}$. See the Commissioning chap. for the calculation of the fan minimum and maximum speeds.

F02 sets the operating mode of the condensation fan.

F02 = 0: always on at maximum speed, independently from the compressors. The fan is only off if the unit passes to stand-by;

F02 = 1: operation in parallel to compressor. The fan is on at maximum speed when the compressor is active;

F02 = 2: on when the corresponding compressor is active, with ON/OFF control based on the temperature/pressure settings for the minimum and maximum speed (parameters F05-F06). When the compressors switch off, the fan deactivates irrespective of the condensing temperature/pressure.

F02 = 3: on when the relative compressor is active with speed control. When the compressor switches off, the fan also switches off irrespective of the condensing temperature/pressure. If the condenser probe is the NTC type, on compressor switch-on, there is fans peak at maximum speed for time F11, irrespective from the temperature measured. In the event of broken condenser probe, the fans are off.

F03 is the minimum threshold for the triac. If FCS, CONVONOFF0, CONV0/10A0 regulators are used, set this parameter at 0.

F034 is the maximum threshold for the triac. If FCS, CONVONOFF0, CONV0/10A0 regulators are used, set this parameter at 100.

F05 is the temperature/pressure set for fan speed. It determines the temperature or pressure below which the fan remains a minimum speed. In the case of regulation ON/OFF represents the temperature or pressure below which the fan is off.

F06 is the temperature/pressure differential. If the speed controller is used, it represents the differential with respect to F05 of the temperature or pressure, above which the fan is activated at maximum speed. In the case of regulation ON/OFF represents the differential above which the fan is on.

F07 is the temperature/pressure differential for switch-off. If the speed controller is used, it represents the differential, with respect to F05, below which the fans switch off. Switch-on has a hysteresis of 1 °C or 0.5 bar if used for the condenser controller, respectively for temperature or pressure probe.

Fan switch-on

F11 is the fan peak time. It establishes the operating time at maximum speed at fan switch-on in order to combat mechanical inertia of the motor. The same timing is respected also on switch-on of the compressor (irrespective of condenser temperature/pressure), if the NTC temperature probe is selected for condenser controller and the speed control is enabled (F02=3); this takes place in order to anticipate the sudden pressure increase (to which a just as quick temperature increase in the area where the probe is positioned does not necessarily correspond) and consequently improve regulation. If F11 = 0 the function is disabled, i.e. the fans are activated at minimum speed and then controlled on the basis of the condensation temperature/pressure.

F12 is the triac impulse duration. It represents the duration of the impulse applied to the triac in milliseconds. For motors with inductive behaviour, set the parameter at 2 (default). Instead, using the CONVONOFF0, CONV0/10A0 modules, FCS regulators, set the parameter at 0.

F14 is the forced ventilation time on start-up in condenser high temperature mode. It establishes the forced ventilation time at maximum speed in the event of start-up with condenser high temperature. The function is operational if the condenser probe is temperature and only for air-water chiller. On start-up of the first compressor of the circuit affected, it is assumed that the environment temperature is near to that present on the condenser; if the value measured by the condenser probe exceeds the value F05-F07, the compressor switches on and the fan of the circuit is forced to the max speed for the time set in F14.

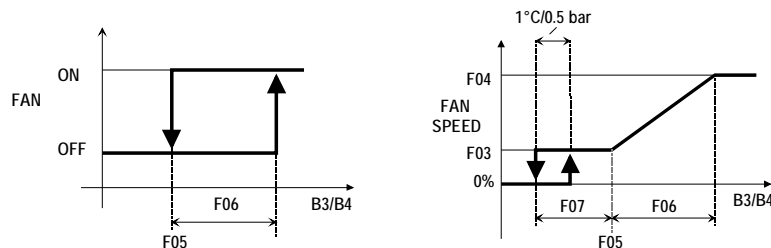

Par.	Description	Def	Min	Max	U.M.
F01	Fan 0 = absent; 1 = present	0	0	1	-
F02	Fan: operating mode 0 = Always on 1 = In parallel to compressor 2 = On/Off 3 = Speed control	0	0	3	-
F03	Minimum voltage threshold for Triac	35	0	F04	step
F04	Maximum voltage threshold for Triac	75	F03	100	step
F05	Fan speed set point in pressure	13	/11	/12	bar
F05	Fan speed set point in temperature	35	-40	176	°C/°F
F06	Fan speed differential in pressure	3	0	30	bar
F06	Fan speed differential in temperature	10	0	50	°C/°F
F07	Minimum fan speed differential in pressure	5	0	F05	bar
F07	Minimum fan speed differential in temperature	15	0	50	°C/°F
F11	Fans peak speed 0 = function disabled	0	0	120	s
F12	Triac impulse duration	2	0	10	s
F14	Fan with high condensing temperature when starting 0 = Disabled	0	0	999	s

6.8 Hot gas bypass

The hot gas by-pass in temperature mode function allows to increase the temperature of the output water from the evaporator. The output enabled is the controller analogue output Y1 (water-water chiller) or Y2 (air-water chiller) of the I/O expansion board.

Par.	Description	Def	Min	Max	U.M.
H25	Hot gas by-pass 0/1 = disabled/enabled	0	0	1	-
H26	Hot gas by-pass in stand-by 0/1 = disabled/enabled	0	0	1	-

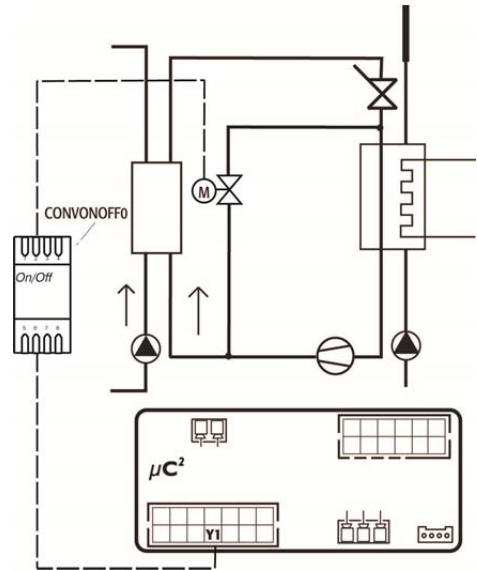

6.9 Pump down

This function allows the unit to be stopped while avoiding the possible formation of liquid refrigerant inside the evaporator. When the only active compressor is called to stop, the expansion valve is closed so as to depressurise the circuit. Valid only when the driver is installed, as the driver pressure probe is used

Par.	Description	Def	Min	Max	U.M.
H13	Enable pump down	0	0	1	-
H14	Pump down minimum pressure	2	0	50	bar
H15	Pump down maximum time	30	0	180	s

6.10 Heaters management

r43 defines the relationship between absolute set-point, intended as electric heaters activation threshold and relative set-point, i.e. electric heaters activation threshold referring to an operational set-point. For example, if r43 = 7, the anti-freeze/support heater will activate below the value of r01-A04, instead of A04.

Par.	Description	Def	Min	Max	U.M.
r43	Heaters set-point: 0=A04, A08, A11, P16, P19 absolute 1=A04, P16, P19 absolute, A08, A11 relative 2=A08, A11, P16, P19 absolute, A04 relative 3=P16, P19 absolute, A04, A08, A11 relative 4=A04, A08, A11 absolute, P16, P19 relative 5=A04 absolute, A08, A11, P16, P19 relative 6=A08, A11 absolute, A04, P16, P19 relative 7=A04, A08, A11, P16, P19 relative	7	0	7	-

Regarding the activation set-points of the heaters, when the temperature measured by the probe B1/B2 (see A06) drops below the value of the parameter A08/A11 the heater or heaters activates, if the respective outputs are set with the parameter H11.

Par.	Description	Def	Min	Max	U.M.
A06	Auxiliary heater probe 0=Control probe (B1) 1=Anti-freeze probe (B2)	0	0	1	-
A08	Heater 1 set point (see r43)	5	A01	80	°C/°F
A08	Heater 1 relative set point (see r43)	2	0	20	°C/°F
A09	Heaters differential	2	0.3	50	°C/°F
A11	Heater 2 set point (see r43)	7	A01	80	°C/°F
A11	Heater 2 relative set point (see r43)	7	0	20	°C/°F

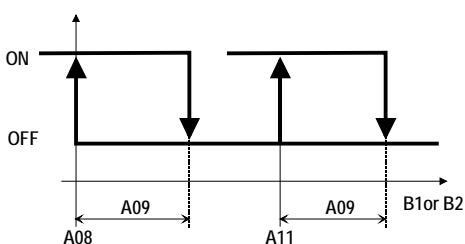

Key
B1/B2 Support heaters probe

7 PARAMETER TABLE

7.1 μ chiller²SE process parameters table

Visibility: F = fan present (F01 = 1); N = B3 NTC probe (if /03 = 1); P = B4 pressure probe (if /04 = 3); V = driver present (if H08 = 1, 5); AA = absolute anti-freeze

AR = relative anti-freeze - = always present

Variable type: A = analog; D = digital; I = Integer

Par.	Description	Level	MIN	MAX	U.M.	DEF.	Disp.	SVP CAREL	ModBus®	R/W	Variable type
Probes setting parameters: /*											
/01	Probe B1 0/1 = Absent/ Present	F	0	1	-	1	-	1	1	R/W	D
/02	Probe B2 0/1 = Absent/ Present	F	0	1	-	1	-	2	2	R/W	D
/03	Probe B3 0 = Absent 1 = Condenser NTC 2 = External NTC 3 = Differential regulation	F	0	3	-	0	-	14	221	R/W	I
/04	Probe B4 0 = Absent 1 = Digital input 2 = External NTC 3 = Ratiometric Condenser 4 = Differential regulation	F	0	4	-	0	-	15	222	R/W	I
/09	Minimum voltage input value	F	0	/10	Vdc/100	50	P	18	225	R/W	I
/10	Maximum voltage input value	F	/09	500	Vdc/100	450	P	19	226	R/W	I
/11	Minimum pressure value	F	0	/12	bar	0	P	1	1	R/W	A
/12	Maximum pressure value	F	/11	99,9	bar	34,5	P	2	2	R/W	A
/13	Probe B1 calibration	F	-12	12	°C/°F	0	-	3	3	R/W	A
/14	Probe B2 calibration	F	-12	12	°C/°F	0	-	4	4	R/W	A
/15	Probe B3 calibration	F	-12	12	°C/°F	0	-	5	5	R/W	A
/16	Probe B4 calibration	F	-12	12	°C/°F /bar	0	-	6	6	R/W	A
/21	Digital filter	U	1	15	-	4	-	20	227	R/W	I
/22	Input limitation	U	1	15	-	8	-	21	228	R/W	I
/23	Unit of measurement 0/1 = °C/°F	U	0	1	-	0	-	5	5	R/W	D

Par.	Description	Level	MIN	MAX	U.M.	DEF.	Disp.	SVP CAREL	ModBus®	R/W	Variable type
Antifreeze/support heater setting parameters: A*											
A01	Anti-freeze alarm set-point	U	A07	A04	°C/°F	3	-	11	11	R/W	A
A02	Anti-freeze alarm differential	U	0,3	122	°C/°F	5	-	12	12	R/W	A
A03	Anti-freeze alarm delay time from switch-on	U	0	150	s	0	-	22	229	R/W	I
A04	Anti-freeze heater/s set-point in stand-by (see r43)	U	A01	80	°C/°F	5	AA	13	13	R/W	A
A04	Anti-freeze heater/s relative set-point in stand-by (see r43)	U	0	20	°C/°F	7	AR	77	77	R/W	A
A05	Anti-freeze heater/s differential in stand-by (see r43)	U	0,3	50	°C/°F	10	-	-	-	R/W	A
A06	Auxiliary heater probe 0 = Control probe (B1) 1 = Anti-freeze probe (B2)	F	0	1	-	0	-	6	6	R/W	D
A07	Anti-freeze alarm set-point limit	F	-40	176	°C/°F	-40	-	15	15	R/W	A
A08	Heater 1 set-point (see r43)	U	A01	80	°C/°F	5	AA	16	16	R/W	A
A08	Heater 1 relative set-point (see r43)	U	0	20	°C/°F	2	AR	78	78	R/W	A
A09	Heaters differential	U	0,3	50	°C/°F	2	-	17	17	R/W	A
A10	Anti-freeze automatic switch-on 0 = Disabled 1 = Heaters and pumps on simultaneously on A4 (see r43) 2 = Do not select 3 = Heaters on at A4	U	0	3	-	0	-	23	230	R/W	I
A11	Heater 2 set point (see r43)	U	A01	80	°C/°F	7	AA	67	67	R/W	A
A11	Heater 2 relative set point (see r43)	U	0	20	°C/°F	7	AR	79	79	R/W	A
A14	Anti-freeze EVD ⁴ alarm set point	U	A07	A04	°C/°F	3	-	81	81	R/W	A

Par.	Description	Level	MIN	MAX	U.M.	DEF.	Disp.	SVP Carel	ModBus®	R/W	Variable type
Probes reading parameters: b*											
b00	Display 0 = Probe B1 2 = Probe B3 4=Do not select 6=Do not select 8=Set point without compensation 9=Set point with compensation 10=ID remote 1 = Probe B2 3 = Probe B4 5=Do not select 7=Do not select 11=Do not select	U	0	11	-	0	-	24	231	R/W	I
b01	Probe B1 reading	D	0	0	°C/°F	0	-	102	102	R	A
b02	Probe B2 reading	D	0	0	°C/°F	0	-	103	103	R	A
b03	Probe B3 reading	D	0	0	°C/°F	0	-	104	104	R	A
b04	Probe B4 reading	D	0	0	°C/°F/bar	0	-	105	105	R	A
b09	Driver evaporation temperature	D	0	0	°C/°F	0	V	110	110	R	A
b10	Driver evaporation pressure	D	0	0	bar	0	V	111	111	R	A
b11	Driver overheating	D	0	0	°C/°F	0	V	112	112	R	A
b12	Driver saturation temperature	D	0	0	°C/°F	0	V	113	113	R	A
b13	Driver valve position	D	0	100	%	0	V	114	114	R	A
b19	Condenser output temperature probe	D	0	0	°C/°F	0	V	120	120	R	A

Par.	Description	Level	MIN	MAX	U.M.	DEF.	Disp.	SVP Carel	ModBus®	R/W	Variable type				
Compressors setting parameters: c*															
c01	Compressor minimum switch-on time	U	0	999	s	60	-	25	232	R/W	I				
c02	Compressor minimum switch-off time	U	0	999	s	60	-	26	233	R/W	I				
c03	Delays between switch-ons of the same compressor	U	0	999	s	360	-	27	234	R/W	I				
c04	Switch-on delay between 2 compressors	U	0	999	s	10	-	28	235	R/W	I				
c05	Switch-off delay between 2 compressors	U	0	999	s	0	-	29	236	R/W	I				
c06	Outputs activation delay	U	0	999	s	0	-	30	237	R/W	I				
c07	Pump-compressor switch-on delay	U	0	999	s	20	-	31	238	R/W	I				
c08	Compressor-pump switch-off delay	U	0	150	min	1	-	32	239	R/W	I				
c09	Maximum operating time of compressor in tandem 0 = function disabled	U	0	60	min	0	-	33	240	R/W	I				
c10	Compressor 1 timer	D	0	800	100 h	0	-	122	122	R	A				
c11	Compressor 2 timer	D	0	800	100 h	0	-	123	123	R	A				
c14	Maintenance request threshold: 0 = function disabled	U	0	100	100 h	0	-	34	241	R/W	I				
c15	Evaporator pump timer	D	0	800	100 h	0	-	126	126	R	A				
c16	Condenser pump timer	D	0	800	100 h	0	-	127	127	R	A				
c17	Pump minimum switch-off time	U	0	150	min	30	-	35	242	R/W	I				
c18	Pump minimum switch-on time	U	0	15	min	3	-	36	243	R/W	I				
c19	Valve-compressor switch-on delay	U	0	100	s	3	-	125	332	R/W	I				
Par. Description Level MIN MAX U.M. DEF. Disp. SVP Carel ModBus® R/W Variable type															
Fans setting parameters: F*															
F01	Fan: 0 = absent; 1 = present	F	0	1	-	0	-	10	10	R/W	D				
F02	Fan: operating mode: 0 = Always on; 1 = In parallel to compressor; 2 = On/Off; 3 = Speed regulation	U	0	3	-	0	F	48	255	R/W	I				
F03	Minimum voltage threshold for Triac	F	0	F04	step	35	F	49	256	R/W	I				
F04	Maximum voltage threshold for Triac	F	F03	100	step	75	F	50	257	R/W	I				
F05	Fan speed set-point in pressure	U	/11	/12	bar	13	FP	23	23	R/W	A				
F05	Fan speed set-point in temperature	U	-40	176	°C/°F	35	FN	24	24	R/W	A				
F06	Fan speed differential in pressure	U	0	30	bar	3	FP	25	25	R/W	A				
F06	Fan speed differential in temperature	U	0	50	°C/°F	10	FN	26	26	R/W	A				
F07	Minimum fan speed differential in pressure	U	0	F05	bar	5	FP	27	27	R/W	A				
F07	Minimum fan speed differential in temperature	U	0	50	°C/°F	15	FN	28	28	R/W	A				
F11	Fans peak speed: 0 = function disabled	U	0	120	s	0	F	51	258	R/W	I				
F12	Triac impulse duration	F	0	10	ms	2	F	52	259	R/W	I				
F14	Fan with high condensing temp. when starting: 0 = Disabled	U	0	999	s	0	FN	91	298	R/W	I				
Par. Description Level MIN MAX U.M. DEF. Disp. SVP Carel ModBus® R/W Var. type															
Machine setting parameters: H*															
H01	Chiller type: 2 = Air-water; 4 = Water-water	F	2	4	-	2	-	54	261	R/W	I				
H04	Number of compressors per circuit 0 = 1 compressor 1 = 2 compressors tandem on 1 circuit 2 = Do not select 3 = Do not select 4 = 1 compressor and a partialization on circuit 1 5 = Do not select	F	0	5	-	0	-	55	262	R/W	I				
H05	Evaporator pump 0 = Absent 1 = Always on 2 = On at request of regulator 3 = On at regulator request and timed	F	0	3	-	1	-	56	263	R/W	I				
H07	Digital input On/Off: 0 = Absent; 1 = Present	U	0	1	-	0	-	15	15	R/W	D				
H08	Network configuration 0 = Control only 1 = Control + EVD 2 = Do not select 3 = Do not select 4 = Control + IO 5 = Control + EVD + IO 6 = Do not select 7 = Do not select	F	0	7	-	0	-	57	264	R/W	I				
H09	Lock keypad: 0 = keypad disabled; 1 = keypad enabled	U	0	1	-	1	-	16	16	R/W	D				
H10	RS485 serial address	U	1	200	-	1	-	58	265	R	I				
H11	Outputs setting (table)	F	0	12	-	0	-	59	266	R/W	I				
			0	1	2	3	4	5	6	7	8	9	10	11	12
N01	compressor 1	compressor 1	compressor 1	compressor 1	compressor 1	compressor 1	compressor 1	compressor 1	compressor 1	compressor 1	compressor 1	compressor 1	compressor 1	compressor 1	compressor 1
N02	heater 1	heater 1	heater 1	-	-	heater 1	heater step 1	heater step 1	heater step 1	heater step 1	compressor 2	compressor 2	compressor 2	P25	
N03	evapor.pump	evaporator pump	evapor.pump	evapor.pump	evapor.pump	evapor.pump	-	-	-	-	-	-	-	-	P26
N04	-	compressor 2 (or partialisation)	compressor 2 (or compressor 1 partialisation)	compressor 2 (or compressor 1 partialisation)	compressor 2 (or compressor 1 partialisation)	compressor 2 (or compressor 1 partialisation)	condenser fan	-	resist. step 2	condenser fan	-	resist. step 1	resist. step 1	resist. step 1	P27
N05	alarm	alarm	-	alarm	alarm	alarm	alarm	alarm	alarm	alarm	alarm	alarm	alarm	alarm	P28
H12	Compressor partialization valve: 0 = Normally excited; 1 = Normally unexcited; 2, 3 = Do not select	F	0	3	flag	1	-	60	267	R/W	I				
H13	Pump down: 0/1 = activated/deactivated	F	0	1	-	0	V	17	17	R/W	D				
H14	Pump down minimum pressure	F	0	50	bar	2	V	37	37	R/W	A				
H15	Pump down maximum time	F	0	180	s	30	V	61	268	R/W	I				
H22	Default parameters setting: 0 = enabled; 1 = disabled	F	0	1	-	0	-	18	18	R/W	D				
H23	Network protocol: 0 = Carel; 1 = ModBus	F	0	1	-	0	-	11	11	R/W	D				
H24	High/low temperature alarm effect 0 = No compressor stop 1 = Stop due to high temperature alarm 2 = Stop due to low temperature alarm 3 = Stop due to high or low temperature alarm	F	0	3	-	0	-	124	331	R/W	I				
H25	Hot gas by-pass: 0 = disabled; 1 = enabled	F	0	1	-	0	-	25	25	R/W	D				
H26	Hot gas by-pass in stand-by: 0 = disabled; 1 = enabled	F	0	1	-	0	-	26	26	R/W	D				

Par.	Description	Level	MIN	MAX	U.M.	DEF.	Disp.	SVP Carel	ModBus®	R/W	Variable type
Alarms setting parameters: P*											
P01	Flow switch alarm delay at pump start-up	U	0	150	s	20	-	63	270	R/W	I
P02	Flow switch alarm delay in normal conditions	U	0	120	s	5	-	64	271	R/W	I
P03	Low pressure alarm delay at compressor start-up	U	0	200	s	40	-	65	272	R/W	I
P04	Compressor partialization in high pressure mode 0 = Deactivated; 1 = Activated; 2 = Do not select; 3 = Do not select	U	0	3	-	0	P	66	273	R/W	I
P05	Alarms reset 0=HP1/LP1/A1/Lt manual 1=HP1/LP1/A1/Lt automatic 2=HP1/A1/Lt manual; LP1 automatic 3=HP1 manual; LP1/A1/Lt automatic 4=HP1/LP1 manual; A1/Lt automatic 5=HP1/LP1 (3 times in one hour) manual; A1/Lt automatic 6=HP1/LP1 (3 times in one hour) manual; A1/Lt manual	F	0	6	-	0	-	67	274	R/W	I
P07	Low pressure alarm with pressure probe: 0 = disabled; 1 = enabled	F	0	1	-	0	P	68	275	R/W	I
P08	Digital input 1 0 = Not used 1 = Flow switch alarm with manual reset 2 = Flow switch alarm with automatic reset 3 = General overload alarm with manual reset 4 = General overload alarm with automatic reset 5 = Thermal overload alarm with manual reset 6 = Thermal overload alarm with automatic reset 7, 8, 9, 10 = Do not select 11 = General alarm with manual reset 12 = General alarm with automatic reset 13 = 2 nd Set-point 14 ...22 = Do not select 23 = ON/OFF remote	F	0	23	-	0	-	69	276	R/W	I
P09	Digital input 2	F	0	23	-	0	-	70	277	R/W	I
P13	Configuration of B4 as digital input if /4=1; See P08	F	0	23	-	0	-	74	281	R/W	I
P15	Low pressure alarm with compressor off; 0/1=not active/active	F	0	1	-	0	-	76	283	R/W	I
P16	High temperature threshold alarm	U	-40	176	°C/°F	28	AA	38	38	R/W	A
P16	Relative high temperature threshold alarm	U	0	100	°C/°F	16	AR	82	82	R/W	A
P17	High temperature on switch-on alarm delay	U	0	250	min	30	-	77	284	R/W	I
P18	High pressure alarm threshold: 0=alarm disabled	F	0	99,9	bar	20	P	39	39	R/W	A
P19	Low temperature alarm threshold	U	-40	176	°C/°F	10	AA	40	40	R/W	A
P19	Relative low temperature alarm threshold	U	0	100	°C/°F	2	AR	83	83	R/W	A
P20	High/low temperature on switch-on protection: 0 = disabled; 1 = enabled	U	0	1	-	0	-	20	20	R/W	D
P21	Alarm relay output logic: 0 = Normally unexcited; 1 = Normally excited	F	0	1	-	0	-	8	8	R/W	D
P24	Compressor action for HP/LP: 0 = switch off compressor 1; 1 = switch off compressor 2	D	0	1	-	0	P	21	21	R/W	D
P25	Digital output 2 0 = No function 1 = Compressor 2 2 = Anti-freeze heater/support 1 3 = Do not select 4 = Evaporator pump 5...7 = Do not select 8 = Condenser fan/pump on/off 9 = Anti-freeze heater/support 2 10 = Alarm 11 = Do not select	F	0	11	-	0	-	108	315	R/W	I
P26	Digital output 3; See P25	F	0	11	-	0	-	109	316	R/W	I
P27	Digital output 4; See P25	F	0	11	-	0	-	110	317	R/W	I
P28	Digital output 5; See P25	F	0	11	-	0	-	111	318	R/W	I
P34	Digital input 5	F	0	23	-	0	-	122	329	R/W	I
P35	Modify alarm relay status with PRG/mute: 0 = No; 1 = Yes	F	0	1	-	0	-	23	23	R/W	D
P36	High pressure alarm management 0 = Always; 1 = With compressor active only, after 2 s from activation	F	0	1	-	0	-	24	24	R/W	D
P37	Digital input 11 0 = Not connected 1...5 = Alarm Ad1...Ad5 6...10 = Warning Ad1...Ad5	F	0	10	-	0	-	138	345	R/W	I
P38	Digital input 12; See P37	F	0	10	-	0	-	139	346	R/W	I
P39	Digital input 13; See P37	F	0	10	-	0	-	140	347	R/W	I
P40	Digital input 14; See P37	F	0	10	-	0	-	141	348	R/W	I
P41	Digital input 15; See P37	F	0	10	-	0	-	142	349	R/W	I
P42	Digital output 11 0 = not used 1...5 = Ad1...Ad5 6 = High pressure alarm 7 = Do not select 8 = Low pressure alarm 9 = Do not select 10 = Circuit thermal overload 11 = Do not select 12 = Flow switch alarm 13 = Low temperature alarm 14 = High temperature alarm 15 = Low temperature alarm at start-up 16 = High temperature alarm at start-up 17 = Pump thermal overload 18 = Do not select	F	0	18	-	0	-	143	350	R/W	I
P43	Digital output 12	F	0	18	-	0	-	144	351	R/W	I
P44	Digital output 13	F	0	18	-	0	-	145	352	R/W	I
P45	Digital output 14	F	0	18	-	0	-	146	353	R/W	I
P46	Digital output 15	F	0	18	-	0	-	147	354	R/W	I

Par.	Description	Level	MIN	MAX	U.M.	DEF.	Disp.	SVP Carel	ModBus®	R/W	Variable type
Regulation setting parameters: r*											
r01	Set point	D	r13	r14	°C/°F	12.0	-	41	41	R/W	A
r02	Differential	D	0.1	50	°C/°F	3.0	-	42	42	R/W	A
r05	Compressors rotation 0 = Disabled 1 = FIFO type 2 = Hours balancing 3 = Do not select	F	0	3	-	0	-	78	285	R/W	I
r06	Type of regulation/compressors use 0 = Proportional Input 1 = Proportional Input + neutral zone 2 = Proportional output 3 = Proportional Output + neutral zone 4 = Timed output with neutral zone	F	0	4	-	0	-	79	286	R/W	I
r07	Neutral zone differential	F	0.1	50	°C/°F	2.0	-	45	45	R/W	A
r08	Output maximum activation time	F	0	999	s	120	-	80	287	R/W	I
r09	Output minimum activation time	F	0	999	s	100	-	81	288	R/W	I
r10	Output maximum deactivation time	F	0	999	s	120	-	82	289	R/W	I
r11	Output minimum deactivation time	F	0	999	s	100	-	83	290	R/W	I
r12	Compressors deactivation differential	F	0	50	°C/°F	2.0	-	46	46	R/W	A
r13	Minimum set-point	U	-40	r14	°C/°F	-40	-	47	47	R/W	A
r14	Maximum set-point	U	r13	176	°C/°F	80	-	48	48	R/W	A
r17	Compensation constant 0 = no compensation	U	-5.0	5.0	-	0	-	51	51	R/W	A
r18	Maximum distance from the set point	U	0,3	20	°C/°F	0,3	-	52	52	R/W	A
r19	Start compensation temperature	U	-40	176	°C/°F	30	-	53	53	R/W	A
r21	Set point from external contact	D	r13	r14	°C/°F	12	-	55	55	R/W	A
r25	Compressors deactivation external temperature -40 = function deactivated	D	-40	80	°C/°F	-40	-	65	65	R/W	A
r27	Accumulation vessel suppression (low load) 0=Disabled 1=Enabled 2, 3 = Do not select	F	0	3	-	0	-	88	295	R/W	I
r28	Min. compressor running time for low load	F	0	999	s	60	-	89	296	R/W	I
r29	Low load differential	F	1.0	50	°C/°F	3.0	-	58	58	R/W	A
r43	Heaters set-point: 0=A4, A8, A11, P16, P19 absolute 1=A4, P16, P19 absolute, A8, A11 relative 2=A8, A11, P16, P19 absolute, A4 relative 3=P16, P19 absolute, A4, A8, A11 relative 4=A4, A8, A11 absolute, P16, P19 relative 5=A4 absolute, A8, A11, P16, P19 relative 6=A8, A11 absolute, A4, P16, P19 relative 7=A4, A8, A11, P16, P19 relative	F	0	7	-	0	-	121	328	R/W	I
r45	Relative regulation maximum set point	D	r46	176	°C/°F	30	-	84	84	R/W	A
r46	Relative regulation minimum set point	F	-40	r45	°C/°F	10	-	85	85	R/W	A
r47	OFF-Differential of compressor for low temperature	F	0.1	10	°C/°F	1.0	-	86	86	R/W	A

Par.	Description	Level	MIN	MAX	U.M.	DEF.	Disp.	SVP Carel	ModBus®	R/W	Variable type
Firmware parameters: F - r*											
H99	Software version	D	0	99.9	int	-	-	1	208	R	I
H97	Driver software version	D	0	99.9	int	-	V	3	210	R	I
H95	Expansion software version (I/O board)	D	0	99.9	int	-	-	149	356	R	I

7.2 Variables accessible only by supervision

-	On-Off 0 = Off; 1 = On	D	0	1	-	0		64	64	R/W	D
-	Digital input 1	D	0	1	-	0		53	53	R	D
-	Digital input 2	D	0	1	-	0		54	54	R	D
-	Digital input 3	D	0	1	-	0		55	55	R	D
-	Digital input 4	D	0	1	-	0		56	56	R	D
-	Digital input 5	D	0	1	-	0		57	57	R	D
-	Digital input B4	D	0	1	-	0		58	58	R	D
-	Digital output 1	D	0	1	-	0		59	59	R/W	D
-	Digital output 2	D	0	1	-	0		60	60	R/W	D
-	Digital output 3	D	0	1	-	0		61	61	R/W	D
-	Digital output 4	D	0	1	-	0		62	62	R/W	D
-	Digital output 5	D	0	1	-	0		63	63	R/W	D
-	Reset alarms	D	0	1	-	0		78	78	R/W	D

8 ALARMS

8.1 Type of alarms

The alarms cause the LED on the display to switch on. There are two types:

- serious: they cause the total switch-off of the controller: e.g. high power supply voltage, communication error with I/O expansion board;
 - slight: cause one or more devices to switch off: high/low pressure alarm (compressor switch-off), anti-freeze (compressor/fan switch-off), etc.
- Their intervention depends on the setting of the threshold and activation delay parameters. The Eeprom alarm always generates controller block. The alarms can be always with automatic reset once the cause has been eliminated or with manual/automatic reset depending on a parameter (P05/P08). The controller digital outputs NO2...NO5 can be configured as alarm relays (parameters P25,..., P28): depending on the alarm that intervenes, the output is excited /unexcited on the basis of parameter P21.

On the basis of the following table, the alarm can cause the output to switch-over (ON), switch-off (OFF) or the output maintains the previous status (-). Instead, the I/O expansion board digital outputs can switch-over individually on the basis of a single alarm (parameters P42, ..., P46).

Par.	Description	Def	Min	Max	U.M.
P05	Alarms reset 0=HP1/LP1/A1/Lt manual 1=HP1/LP1/A1/Lt automatic 2=HP1/A1/Lt manual; LP1 automatic 3=HP1 manual; LP1/A1/Lt automatic 4=HP1/LP1 manual; A1/Lt automatic 5=HP1/LP1 (3 times in one hour) manual; A1/Lt automatic 6=HP1/LP1 (3 times in one hour) manual; A1/Lt manual	0	0	6	-
P21	Alarm relay output logic: 0/1=Normally unexcited/excited	0	0	1	-

Example: probe B1 alarm

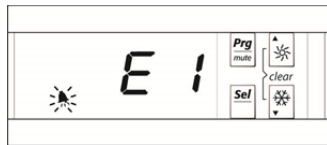

ALARMS TABLE

Alarm display	Alarm type	Reset	Compressor	Pump	Fan	Heater	Exp. valve	Output alarm	I/O exp. board	Superv. variable	Superv. variab. description	Variable type
I/O	Communication error with I/O board	Automatic	OFF	OFF	OFF	OFF	OFF	OFF	-	-	Display signal	Digital
HP1	High pressure	Depends on P05	OFF C1-2	-	ON(60")	-	-	ON	-	41 (R)	Circuit 1 alarm	Digital
LP1	Low pressure	Depends on P05	OFF C1-2	-	OFF	-	-	ON	-	41 (R)	Circuit 1 alarm	Digital
tP	General thermal overload	Depends on P08	OFF	OFF	OFF	-	-	ON	-	45 (R)	General alarm	Digital
tC1	Circuit 1 thermal overload	Depends on P08	OFF C1-2	-	OFF	-	-	ON	-	41 (R)	Circuit 1 alarm	Digital
LA	General warning	Depends on P08	-	-	-	-	-	ON	-	50 (R)	General warning	Digital
FL	Flow switch alarm	Depends on P08	OFF	OFF	OFF	-	-	ON	-	45 (R)	General alarm	Digital
FLb	Backup pump warning	Automatic	-	-	-	-	-	-	-	50 (R)	General warning	Digital
E1	Probe B1 alarm	Automatic	OFF	OFF	OFF	OFF	-	ON	-	46 (R)	Probes alarm	Digital
E2	Probe B2 alarm	Automatic	OFF	OFF	OFF	OFF	-	ON	-	46 (R)	Probes alarm	Digital
E3*	Probe B3 alarm	Automatic	OFF	OFF	OFF	OFF	-	ON	-	46 (R)	Probes alarm	Digital
E4*	Probe B4 alarm	Automatic	OFF	OFF	OFF	OFF	-	ON	-	46 (R)	Probes alarm	Digital
Hc1-2	Comp. 1-2/pumps hour warning	Automatic	-	-	-	-	-	-	-	47 (R)	Compress. warning	Digital
EPr	EEPROM error during operation	Automatic	-	-	-	-	-	-	-	50 (R)	General warning	Digital
EPb	EEPROM error at start-up	Automatic	OFF	OFF	OFF	OFF	OFF	OFF	-	45 (R)	General alarm	Digital
EL1	Zero crossing	Automatic	-	-	100%	-	-	ON	-	52 (R)	Fans warning	Digital
A1	Anti-freeze alarm	Depends on P05	OFF C1-2	-	OFF	-	-	ON	-	41 (R)	Circuit 1 alarm	Digital
Ht	High temperature	Automatic	-	-	-	-	-	ON	-	51 (R)	Temperature warning	Digital
Lt	Low ambient temp.	Depends on P05	-	-	-	-	-	ON	-	51 (R)	Temperature warning	Digital
AHt	High temperature at start-up	Automatic	OFF	-	OFF	OFF	-	-	-	50 (R)	General warning	Digital
ALt	Low temperature at start-up	Automatic	OFF	-	OFF	OFF	-	-	-	50 (R)	General warning	Digital
ELS	Low supply voltage	Automatic	-	-	-	-	-	-	-	50 (R)	General warning	Digital
EHS	High supply voltage	Automatic	OFF	OFF	OFF	OFF	OFF	OFF	-	45 (R)	General alarm	Digital
Ed1	EVD tLAN error	Automatic	OFF C1-2	-	OFF	-	-	ON	-	43 (R)	EVD alarm	Digital
SH1	EVD overheat alarm	-	OFF C1-2	-	OFF	-	-	ON	-	43 (R)	EVD alarm	Digital
nO1	MOP warning	Automatic	-	-	-	-	-	-	-	48 (R)	EVD warning	Digital
LO1	LOP warning	Automatic	-	-	-	-	-	-	-	48 (R)	EVD warning	Digital
HA1	High inlet temperature warning circ.1	Automatic	-	-	-	-	-	-	-	48 (R)	EVD warning	Digital
EP1	EVD Eeprom error	Automatic	OFF C1-2	-	OFF	-	-	ON	-	43 (R)	EVD alarm	Digital
ES1	EVD probe error	Automatic	OFF C1-2	-	OFF	-	-	ON	-	43 (R)	EVD alarm	Digital
EU1	Open valve EVD 1 error at start-up	Automatic	OFF C1-2	-	OFF	-	-	ON	-	43 (R)	EVD alarm	Digital
Eb1	EVD battery alarm	Automatic	OFF C1-2	-	OFF	-	-	ON	-	43 (R)	EVD alarm	Digital
L	Low load warning	Automatic	-	-	-	-	-	-	-	-	Display signal	-
Ed1	tLan EVD communication error	Automatic	OFF C1-2	-	OFF	-	-	ON	-	43 (R)	EVD alarm	Digital
PH1	Partialisation warning due to high pressure	-	-	-	-	-	-	-	-	-	Display signal	-
Ad1	Dig. input 11 warning	Manual	-	-	-	-	-	ON	√	86 (R)**	OUT 11 state	Digital
Ad1	Dig. input 11 alarm	Manual	OFF	OFF	OFF	OFF	OFF	ON	√	86 (R)**	OUT 11 state	Digital
Ad2	Dig. input 12 warning	Manual	-	-	-	-	-	ON	√	87 (R)**	OUT 12 state	Digital
Ad2	Dig. input 12 alarm	Manual	OFF	OFF	OFF	OFF	OFF	ON	√	87 (R)**	OUT 12 state	Digital
Ad3	Dig. input 13 warning	Manual	-	-	-	-	-	ON	√	88 (R)**	OUT 13 state	Digital

Alarm display	Alarm type	Reset	Compressor	Pump	Fan	Heater	Exp. valve	Output alarm	I/O exp. board	Superv. variable	Superv. variab. description	Variable type
Ad3	Dig. input 13 alarm	Manual	OFF	OFF	OFF	OFF	OFF	ON	√	88 (R)**	OUT 13 state	Digital
Ad4	Dig. input 14 warning	Manual	-	-	-	-	-	ON	√	89 (R)**	OUT 14 state	Digital
Ad4	Dig. input 14 alarm	Manual	OFF	OFF	OFF	OFF	OFF	ON	√	89 (R)**	OUT 14 state	Digital
Ad5	Dig. input 15 warning	Manual	-	-	-	-	-	ON	√	90 (R)**	OUT 15 state	Digital

(*): if the probe is set for compensation, the unit will continue to operate in the event of a fault.
(**): status of the output selected with parameters P42...P46.

8.2 Alarm description

HP1: high pressure. The alarm is detected irrespective of the status of the pump and the compressors. The compressors are immediately stopped (ignoring the set protection times), the alarm relay is activated, and the display starts flashing. The condensing fan is activated at maximum speed for 60 s to oppose the alarm, after which it is switched off. This alarm may also be generated when the high pressure limit is exceeded (active only when pressure transducer is fitted) set by the parameter P18, which to be enabled must be greater than 3.0 bar, due to the corresponding hysteresis. The following figure the graphics shows alarm automatic reset.

Par.	Description	Def	Min	Max	U.M.
P18	High pressure alarm threshold 0=alarm disabled	20	0	99,9	bar
P36	High pressure alarm management 0 = Always 1 = With compressor active, after 2 s from activation	0	0	1	-

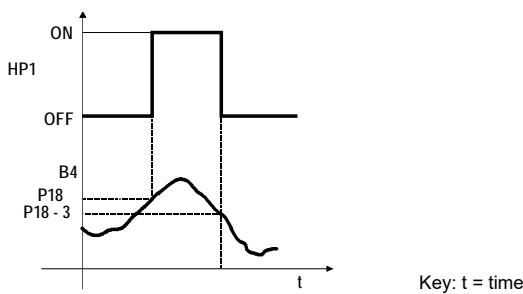

LP1: Low pressure

The alarm depends on P15, on P7 and on P3.

P15=1, P07= 1: the alarm is detected after time P03 with compressors off or active depending on P15. The hysteresis for this alarm is 1 bar.

tP: General overload

The alarm is detected irrespective of the status of the pump and the compressors. The compressors, the pumps and fans stop (without observing the protection times) or are inhibited from starting, the alarm relay is activated, the display flashes the corresponding message, and the LED flashes. It can be reset either manually or automatically (see par. P08, P09, P13).

tC1: Circuit thermal overload.

LA: general warning.

This represents a generic warning that appears on the display, via digital input, without modifying the operation of the unit, the alarm relay will be activated.

FL: flow switch alarm.

This alarm is detected only if the pump is on (excluding the delays when starting P01 and P02 in normal conditions), irrespective of the status of the compressor. All outputs are disabled: pump, compressor (without respecting switch-off times), condenser fan and the alarm relay is activated and the display flashes. The presence of the utility water pump must be enabled (H5≠0). It can be reset either manually or automatically (see P08, P09, P13).

Par.	Description	Def	Min	Max	U.M.
P01	Flow switch alarm delay at pump start-up	20	0	150	s
P02	Flow alarm delay in normal conditions	5	0	120	s
P03	Low pressure alarm delay at compressor start-up	40	0	200	s

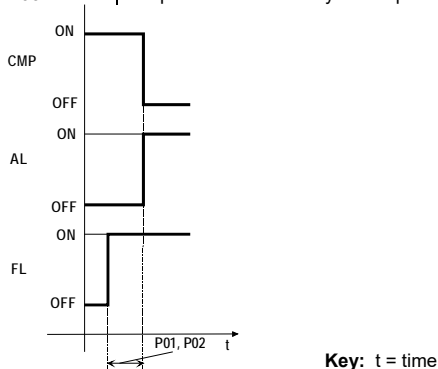

E1...E4: probe error detected also with machine in Stand-by. The presence of a probe alarm leads to the deactivation of the compressor, the condenser fan, pump and heater; the alarm relay and display flashing are activated. In the event of external probe fault and compensation function enabled, the unit continues to operate correctly, the function deactivates, a warning is activated via the alarm relay and the message appears on the display from E1 to E4 for probes B1 to B4.

Hc1, Hc2: compressors/pumps operating hour limit exceeded warning. When the number of operating hours for the compressor exceeds the maintenance threshold (see par. c14), the maintenance request signal is activated.

EPr, EPb: EEPROM error

It is a parameters memorisation problem in the non-volatile machine memory (EEPROM); μC^2SE continues to make the regulations with the data present in the volatile memory (RAM) if it is EPr, where there is a physical copy of all data. The configuration is lost if a power-cut occurs. The alarm relay is not activated. If the "EPb" error occurs on switch-on, the controller remains blocked.

EL1: zero crossing error warning. If the controller detects errors in the power supply voltage, it is possible to lose control of fan speed. In this case, the display will show the warning, the fans will be ordered at maximum speed only if at least one compressor is active. Reset will be automatic, so as not to penalise unit operation. The function is enabled only with F02= 3.

A1: anti-freeze alarm. A07 establishes the minimum limit that can be used to set the anti-freeze alarm set point (A01). The alarm is detected via the evaporator output water probe (B2) or, if there is an electronic expansion valve driver (EVD) connected in tLAN, on the basis of the evaporation temperature communicated by the driver itself. The temperature of the water leaving the evaporator is compared with the alarm threshold A01, while the evaporation temperature is compared with the threshold A14. The compressors are switched off immediately; the condenser fan is activated along with the alarm relay and flashing display. Whenever μC^2SE is in stand by the alarm condition is not detected, but just the heaters are managed. Reset depends on parameter P05:

1. in the event of automatic reset, the unit re-starts automatically if the temperature is above the value of A01+A02 or A14+A02.
2. in the event of manual reset, the unit re-starts manually also if the alarm is active.

After time A03, the unit blocks again if the alarm remains.

Par.	Description	Def	Min	Max	U.M.
A01	Anti-freeze alarm set point	3,0	A07	A04	°C/°F
A07	Anti-freeze alarm threshold limit	-40	-40	176	°C/°F
A02	Anti-freeze alarm differential	5,0	0,3	122	°C/°F
A03	Anti-freeze alarm delay time from switch-on	0	0	150	s

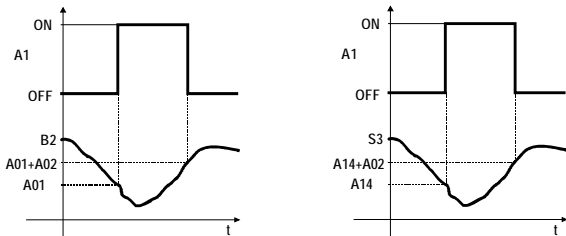

Key:
B2 = Evaporator output probe
S3 = EVD⁴ driver evaporation probe

Ht: high temperature warning. Signalling is activated if the threshold is exceeded (read by B1), which is stated in parameter P16. This is delayed on switch-on by the parameter P17 and causes switch-on of the alarm relay without deactivation of the outputs and reset is automatic when the conditions that generated it have been removed.

Par.	Description	Def	Min	Max	U.M.
P16	High temperature threshold alarm	28	-40	176	°C/°F
P16	Relative high temperature threshold alarm	16	0	100	°C/°F
P17	High temperature on switch-on alarm delay	30	0	250	min

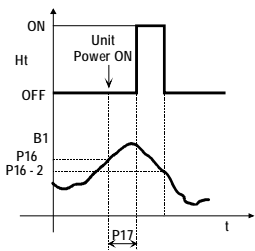

Key:
P16 High temperature alarm threshold
Ht High temperature alarm
B1 Temperature probe
t Time

Lt: low temperature warning. This alarm can be reset manually or automatically and this depends on parameter P05. The effect of the Ht/Lt alarms on the compressor depends on parameter H24.

Par.	Description	Def	Min	Max	U.M.
P19	Low temperature alarm threshold	10	-40	176	K/°F
P19	Relative low temperature alarm threshold	2	0	100	°C/°F
P20	High/low temperature on switch-on protection 0/1=disabled/enabled	0	0	1	-
H24	High/low temperature alarm effect 0: No compressor stop 1: Stop due to high temperature alarm 2: Stop due to low temperature alarm 3: Stop due to high or low temperature alarm	0	0	3	-

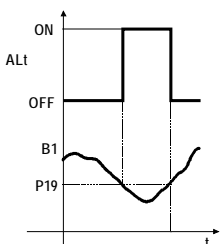

Key
P19 Low temperature at switch-on alarm set
Alt Low temperature on switch-on warning
B1 Temperature probe
t Time

AHt: high temperature on plant switch-on warning. The warning does not activate the relay and displays the "AHt" message.

ALt: low temperature on plant switch-on warning. The warning does not activate the relay and displays the "Alt" message.

ELS/EHS: warning low/alarm high power supply voltage warning. If the power supply voltage is too high or too low, the relative message appears on the display. Correct operation of $\mu\text{C}^2\text{SE}$ is not guaranteed. The low voltage only leads to the execution of the loads switch-off request. Any switch-on requests remain pending. High voltage leads to switch-off of all excited relays.

L: low load condition warning. The warning does not activate the relay and displays the "L" message; reset is automatic.

Driver

All of the driver alarms that block the unit are self-resetting, for $\mu\text{C}^2\text{SE}$. Therefore the possibility to select self-reset of the entire system must be selectable from the driver itself via the relevant parameters. $\mu\text{C}^2\text{SE}$ can give the Go Ahead command according to the usual alarms reset procedure from keyboard.

Ed1: tLAN communication error with the Driver.

The alarm is generated after a fixed time (5 s) from when $\mu\text{C}^2\text{SE}$ has lost contact with the Driver. In this case, the unit is inhibited for safety reasons.

SH1: low overheating alarm.

The low overheating of circuit 1 alarm, stops circuit 1 for safety reasons after a fixed period of time (5 s). The risk is that the compressors are flooded.

nO1: MOP warning (maximum operational pressure).

The warning appears on the display.

LO1: LOP warning (minimum operational pressure).

The warning appears on the display.

HA1: evaporator high temperature warning. The warning appears on the display.

EP1: EEPROM driver error. The circuit is inhibited for safety reasons, as there is no driver status.

ES1: probes driver error. The circuit is inhibited for safety reasons, as there is no driver status.

EU1: Valve open error EVD 1 start I, in system start-up, the driver detects the valve is still open, the alarm has passed to $\mu\text{C}^2\text{SE}$, which switches the compressors and fans off.

Eb1: EVD battery alarm. The EVD battery alarm inhibits compressor start-up to prevent the risk of liquid return from the circuit and relative fans.

8.3 Alarm digital inputs/outputs

Alarm digital inputs

The following digital inputs cannot be configured (see wiring diagram):

ID3	High pressure alarm input
ID4	Low pressure alarm input

The configuration of the digital inputs as for flow switch/pump thermal overload/general alarms with manual/automatic reset can be performed from parameter. If the device connected to the digital input intervenes, the alarm occurs with that displayed described in the alarms table.

Alarm digital outputs

The following digital output cannot be configured.

NO1 Compressor output

$\mu\text{C}^2\text{SE}$: the function of digital outputs as alarm can be configured from parameter (P25...P28). On occurrence of any of the alarms in the alarms table, the output selected as alarm output switches-over.

I/O expansion board: the function of digital outputs as alarm can be configured from parameter (P42...P46). In this case, the output only switches-over if the selected alarm occurs.

Par.	Description	Def	Min	Max	U.M.
P21	Alarm relay output logic 0/1=Normally unexcited/excited	0	0	1	0
P25	Digital output 2 selection - 10 = Alarm	0	0	11	0
P26	Digital output 3 selection - See P25	0	0	11	0
P27	Digital output 4 selection - See P25	0	0	11	0
P28	Digital output 5 selection - See P25	0	0	11	0
P42	Digital output 11 selection 0 = not used	0	0	18	0
	1...5 = Ad1...Ad5				
	6 = Circuit 1 high pressure alarm				
	8 = Circuit 1 low pressure alarm				
	10 = Circuit 1 thermal overload				
	12 = Flow switch alarm				
	13 = Low temp. alarm				
	14 = High temp. alarm				
	15 = Low temperature alarm at start-up				
	16 = High temperature alarm at start-up				
17 = Pump thermal overload					
18 = Do not select					
P43	Digital output 12 selection - See P42	0	0	18	-
P44	Digital output 13 selection - See P42	0	0	18	-
P45	Digital output 14 selection - See P42	0	0	18	-
P46	Digital output 15 selection - See P42	0	0	18	-

9 TECHNICAL SPECIFICATIONS

“Group A” is defined successively, the collection of the following outputs: valve, pump, compressor, heater.

Power supply	24 Vac, range +10/-15 %; 50/60 Hz Maximum input power: 3 W Fuse mandatory in series with $\mu\text{C}^2\text{SE}$ power supply: 315 mA
12-way connector	Max. current 2 A for every relay output, extendible to 3 A for individual output
Relay	Max. current at 250 Vac: EN60730: Resistive: 3 A, Inductive: 2 A $\cos\phi = 0.4$; 60000 cycles UL: Resistive: 3 A, 1 FLA, 6 LRA $\cos\phi = 0.4$ 30000 cycles For further information consult the specifications stated in figure Minimum interval between the communications (every relay): 12 s (it is the task of the machine manufacturer in which the device is incorporated to guarantee the correct configuration in order to respond to this specification) Type of micro switch interruption action of the relays: 1 C Isolation between group A relays: operational Isolation between group A relays and the very low voltage: reinforced Isolation between group A relays and the signalling relay: main Isolation between the signalling relay and the very low voltage: reinforced Isolation between the relays and the front panel: reinforced
Digital Inputs	Electric standard: free contact Closing current referring to mass: 5 mA Maximum closing resistance: 50 W
Analogue inputs	CAREL NTC temperature probes (10 kW at 25 °C) Response time depends on the component used, typical value 90 s. B4: NTC temp. probes (10 kW at 25 °C) or ratiom. pressure probes CAREL 0...5 V SPK*00**R*
Fan output	Control signal for CAREL modules MCHRTF****, CONVONOFF* and CONV0/10A* Impulse position modulation (settable width) or modulation of the duty cycle Unloaded voltage: 5 V \pm 10% Short circuit current: 30 mA Minimum output load: 1 k Ω
Front protection rating	IP55
Storage conditions	-10T70 °C – humidity 80% R.H. non condensing
Operating conditions	-10T55 °C – humidity 90% R.H. non condensing
Level of pollution	Normal
Heat and fire resistance cat.	D (UL94 V0)
PTI of the isolating materials	All isolating materials have PTI \geq 250 V
Class and structure of the software	A
Period of electric stress across insulating parts	Long
Type-approvals	CE/UL (File EI98839 sec.16)



Note: all relays must have the common (C1/2, C3/4) connected together.

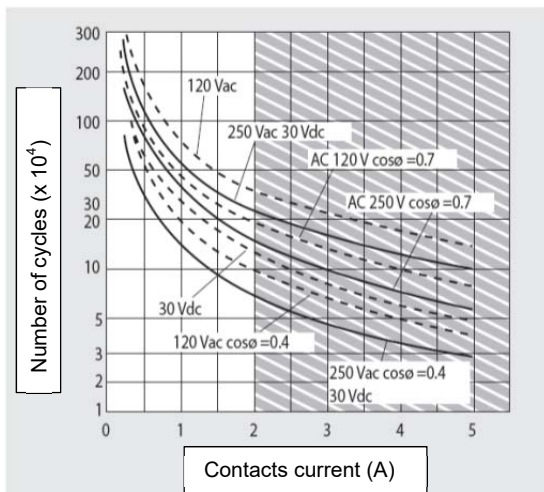

Operational specifications

Analogue inputs resolution	Temperature probes: interval -40T80 °C, 0.1 °C Interval -20T20 °C, ± 0.5 °C (probe excluded) Interval -40T80 °C, ± 1.5 °C (probe excluded)
Pressure measurement error	The % voltage error with a range of input from 0.5 to 4.5 is $\pm 2\%$ (excluding probe). The error in the converted value may vary according to the settings of parameters /9, /10, /11, /12

Connector specifications

The connectors may be purchased using CAREL code (MCHCON0***) or from the Molex® manufacturer

Connector Molex® code	Number of ways
39-01-2120	12
39-01-2140	14

Max. number of insertion/removal cycles for the connectors: 25 cycles

Code of the contacts according to the cross-section of the connection cables to the 12- and 14-pin connectors (use the special Molex® tool code 69008-0724 for crimping)

Contact Molex® code	Cable section allowed
39-00-0077	AWG16 (1.308 mm ²)
39-00-0038	AWG18-24 (0.823...0.205 mm ²)
39-00-0046	AWG22-28 (0.324...0.081 mm ²)

MCHSMLC*** pre-wired kits are also available



WARNINGS

- If one transformer is used to supply both the $\mu\text{C}^2\text{SE}$ and the accessories, all the G0 terminals on the various controllers or the various boards must be connected to the same terminal on the secondary, and all the G terminals to the other terminal on the secondary, so as to avoid damaging the instrument;
- For use in residential environments, use shielded cable (two wires + shield earthed at both ends, AWG 20-22) for the tLAN connections (EN 55014-1);
- Avoid short-circuits between V+ and GND so as not to damage the instrument. Perform all the maintenance and installation operations when the unit is not connected to the power supply;
- Separate the power cables (relay outputs) from the cables corresponding to the probes, digital inputs and serial line;
- Use a transformer dedicated exclusively to the electronic controllers for the power supply.

Protection against electric shock and maintenance warnings

The system made up of the control board (MCH200005*) and the other optional boards (MCH200006*, MCH200485*, MCHRTF****, CONVONOFF*, CONV0/10A*, EVD000040*) constitute a control device to be integrated into class I or class II appliances. The class of protection against electric shock depends on how the control device is integrated into the unit built by the manufacturer. Disconnect power supply before working on the board during assembly, maintenance and replacement. The protection against short circuits due to faulty wiring must be guaranteed by the manufacturer of the appliance that the controller will be fitted on.

Maximum length of the connection cables

NTC probes/ratiometric connection cables	10 m
Digital input connection cables	10 m
Power outputs connection cables	5 m
Fan drive output connection cables	5 m
Power supply cables	

9.1 Software releases

Revision	Description
1.5	The parameters that in release 2.0 were indicated as "do not select" are not more visible: c12, c13, F15, F16, H02, H03, H06, H21, P22, P33, r30, r47, r48, all "t" parameters
	Default values modified: H08: from 4 a 0; r43: from 7 a 0; A08: from 25 a 5; A11: from 25 a 7
	The function of remote On/Off from digital input is now correct
Revision	The function of programming key is now correct
1.5	Range parameter P18 modified (0...99.9)

CAREL

CAREL INDUSTRIES HeadQuarters

Via dell'Industria, 11 - 35020 Brugine - Padova (Italy)

Tel. (+39) 049.9716611 - Fax (+39) 049.9716600

e-mail: carel@carel.com - www.carel.com